

ผลิตภัณฑ์คุณภาพ โดย NED

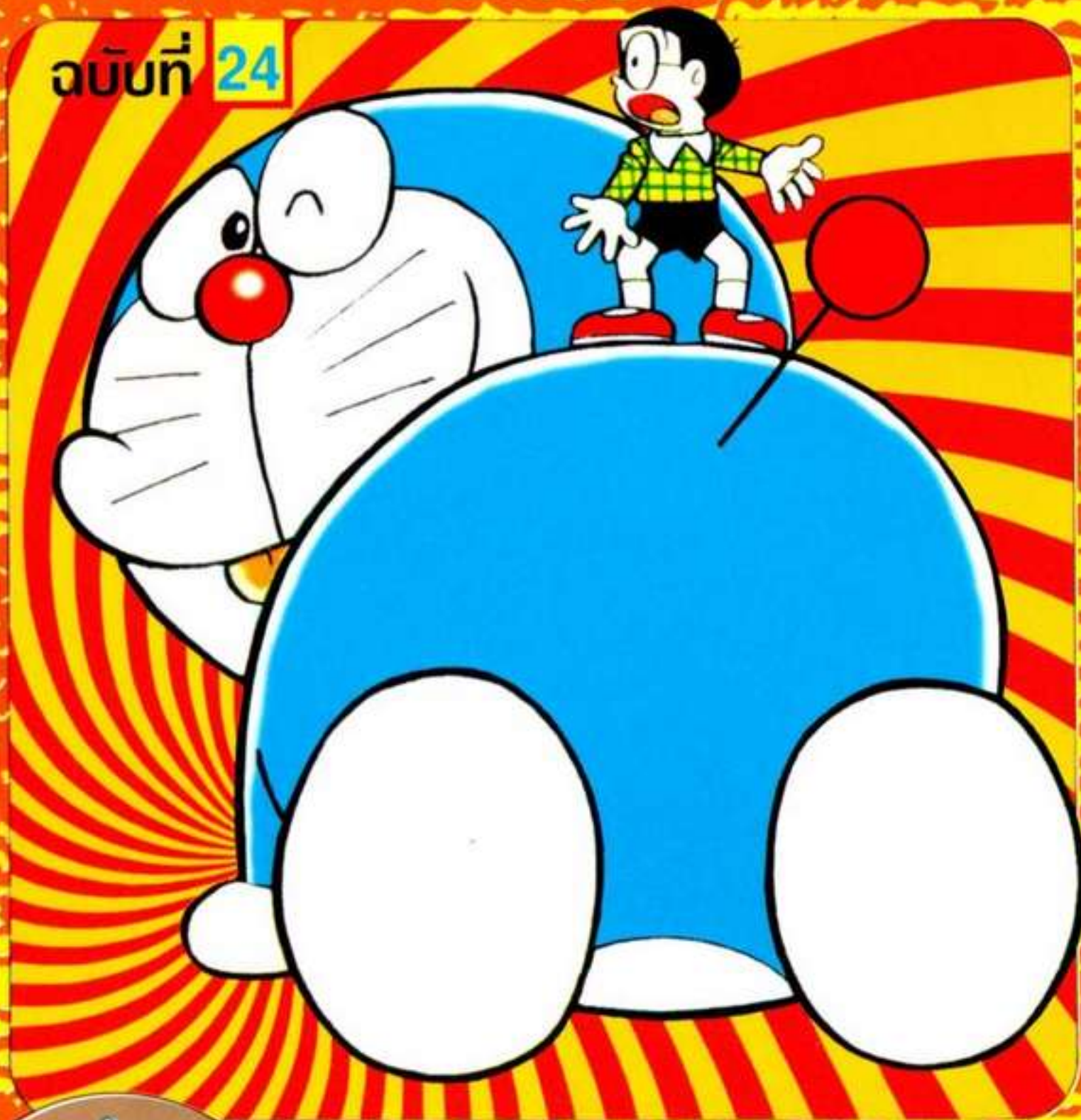

โดราเอมอน

ฉบับที่ 24



อ. ฟุจิโอะ · F · ฟุจิโอะ

ISBN974-89528-7-8 **ชุดสำหรับนักเรียน**

เช็คอุปกรณ์ของไมบิตะ





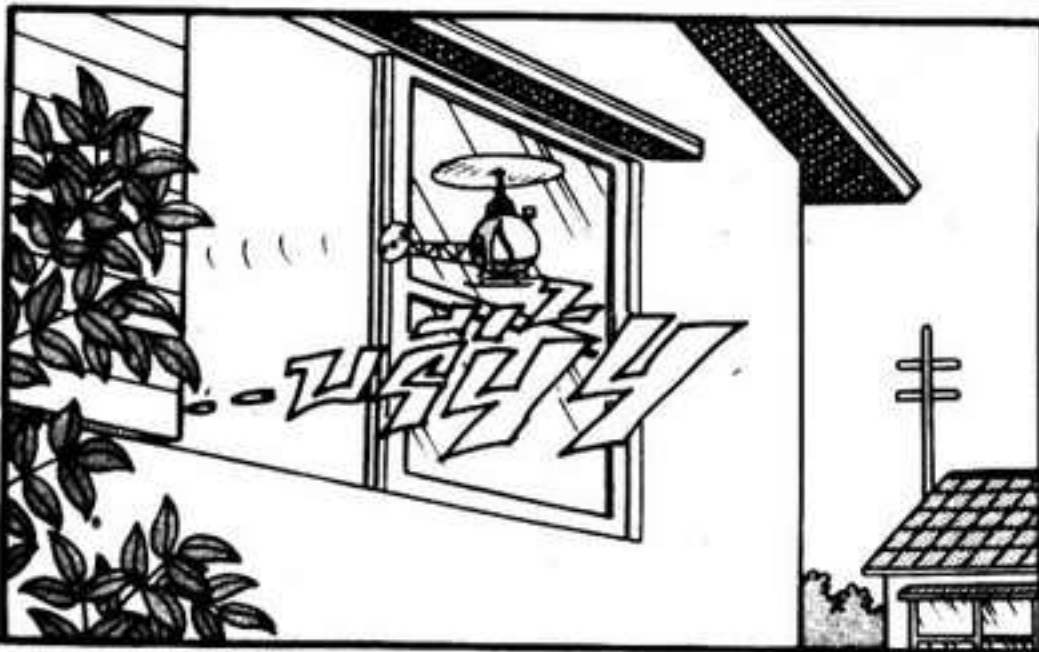
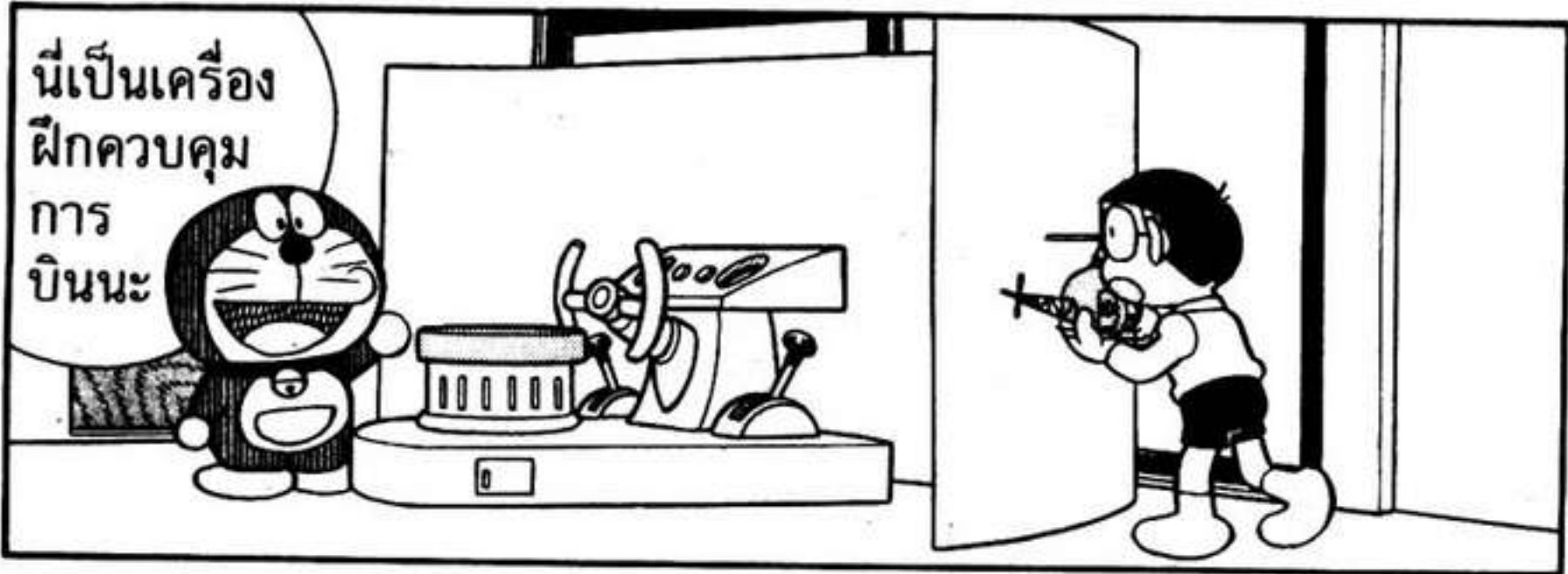

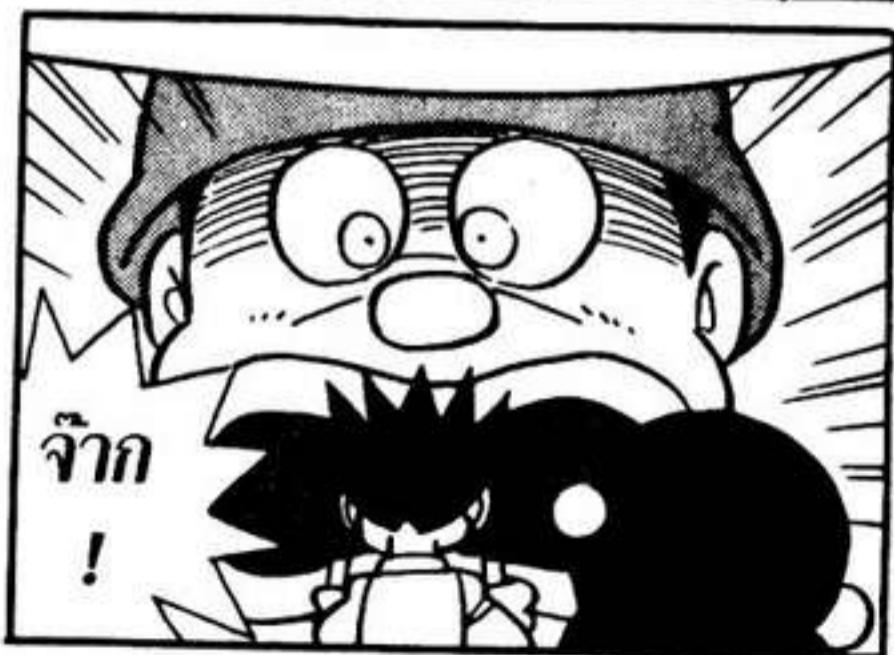
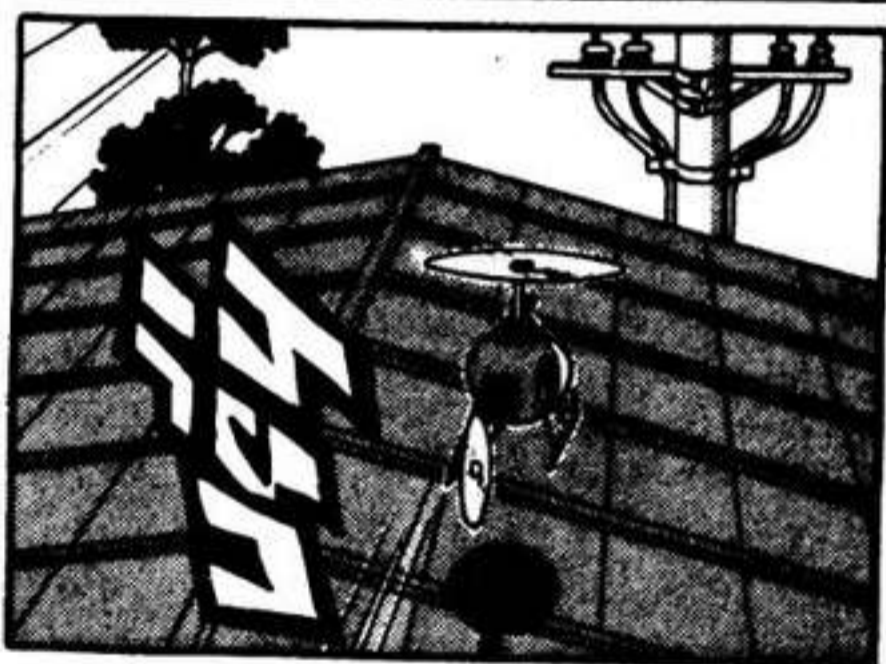
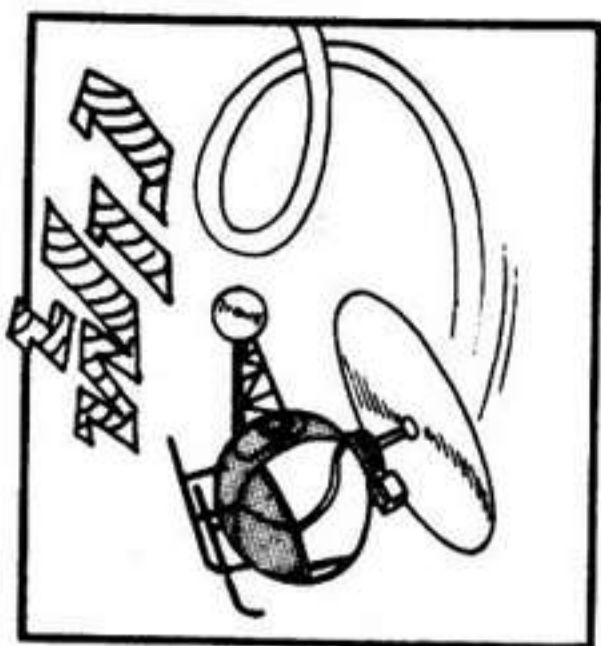



หยุดชม
ทิวทัศน์
ก็ได้
ด้วย...

เค้าเรียกว่า
บิน
ฉวัดเฉวียน



เล่นได้
จับนก
ตัว
น้อยๆ

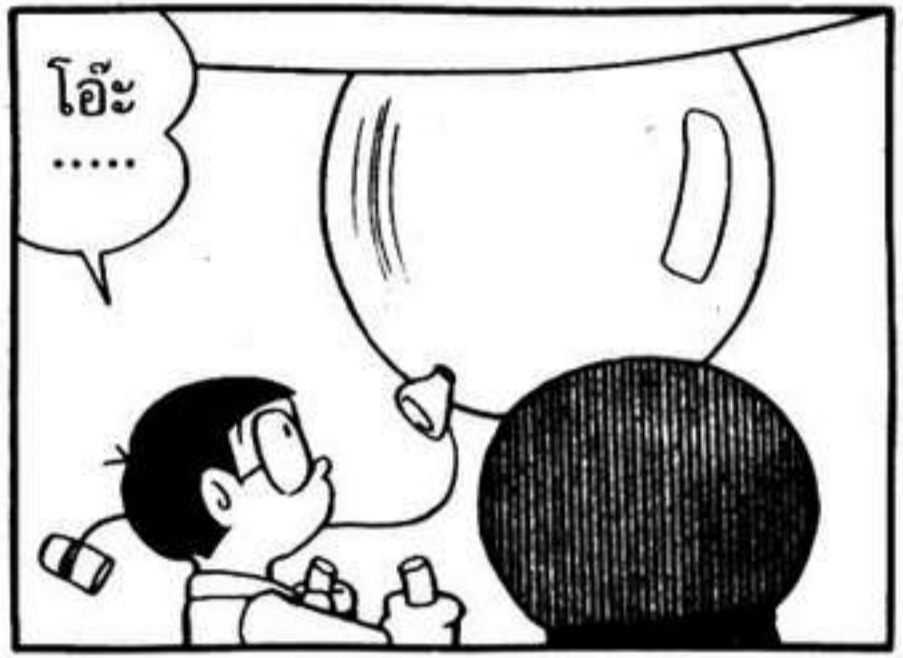

โอ๊ะ
.....



ทุกคน
อยู่ที่
ลานว่าง
นั่นะ



กดปุ่มนั้น
ก็จะ
ถ่ายภาพได้

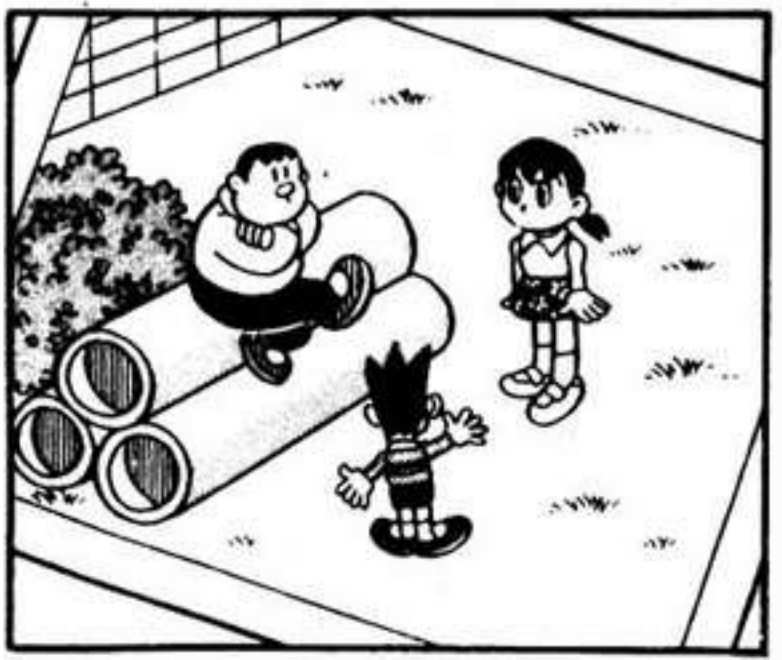



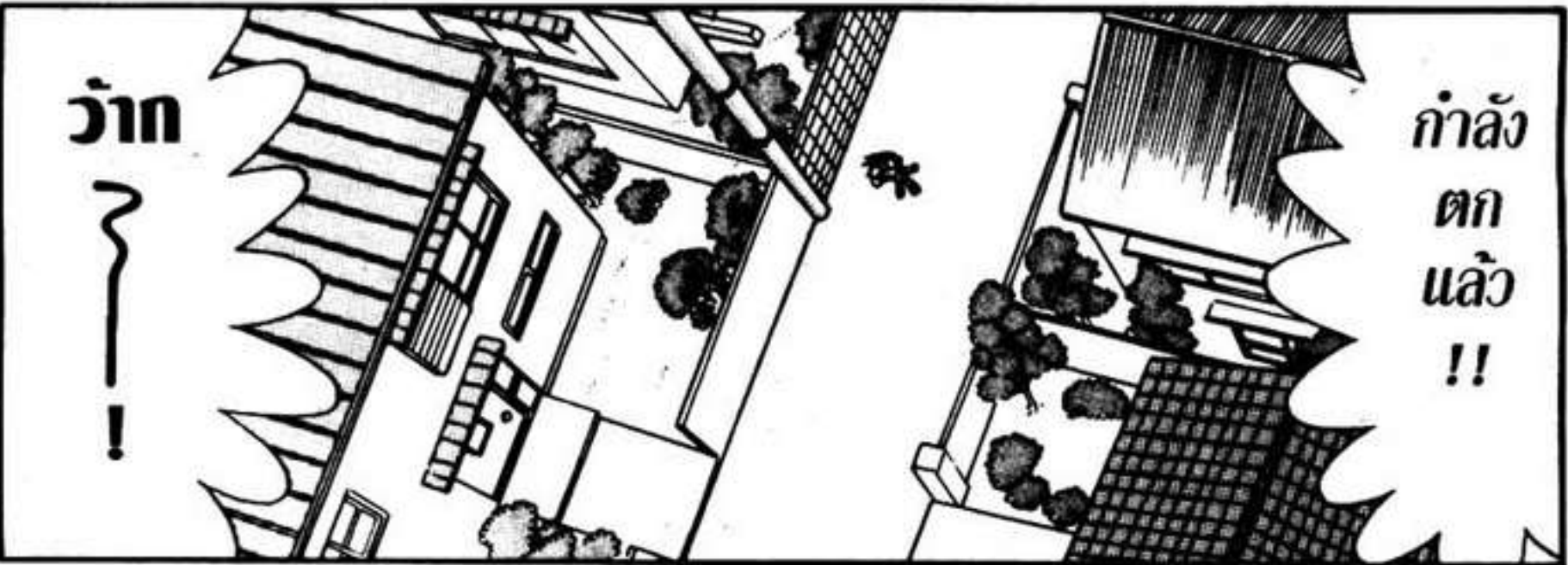
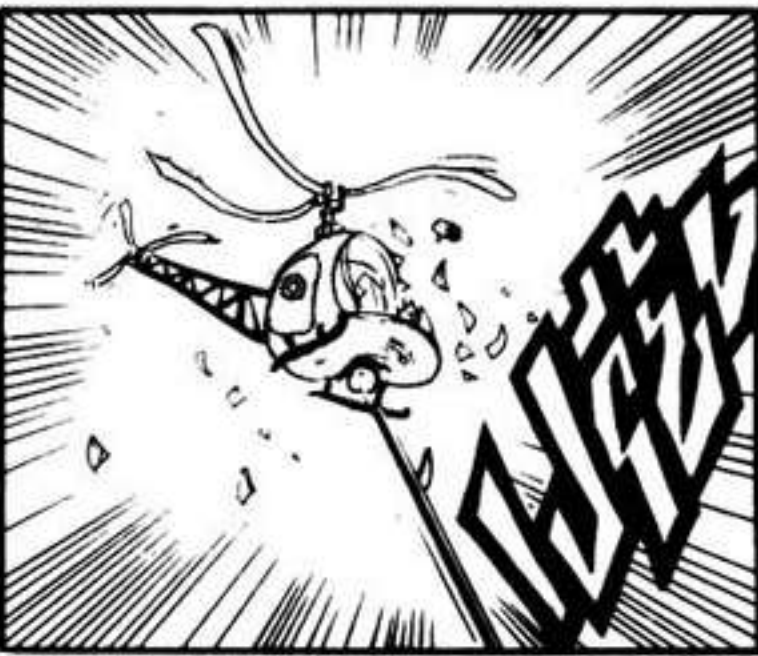

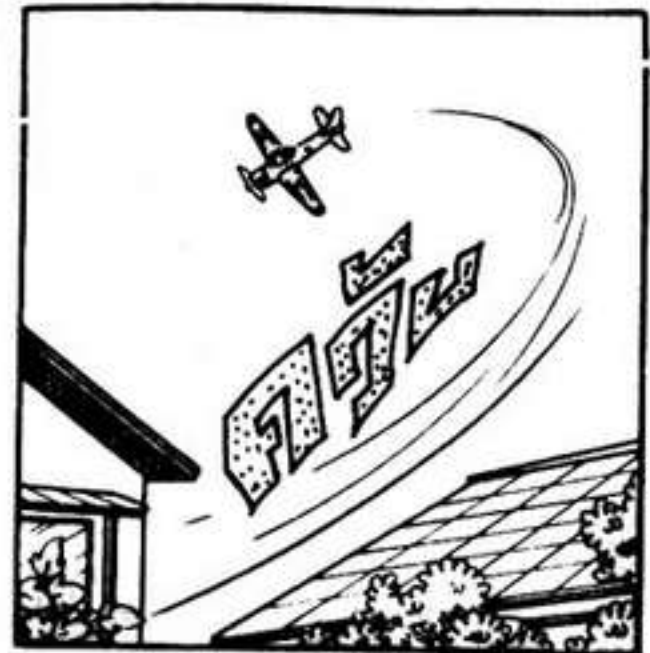
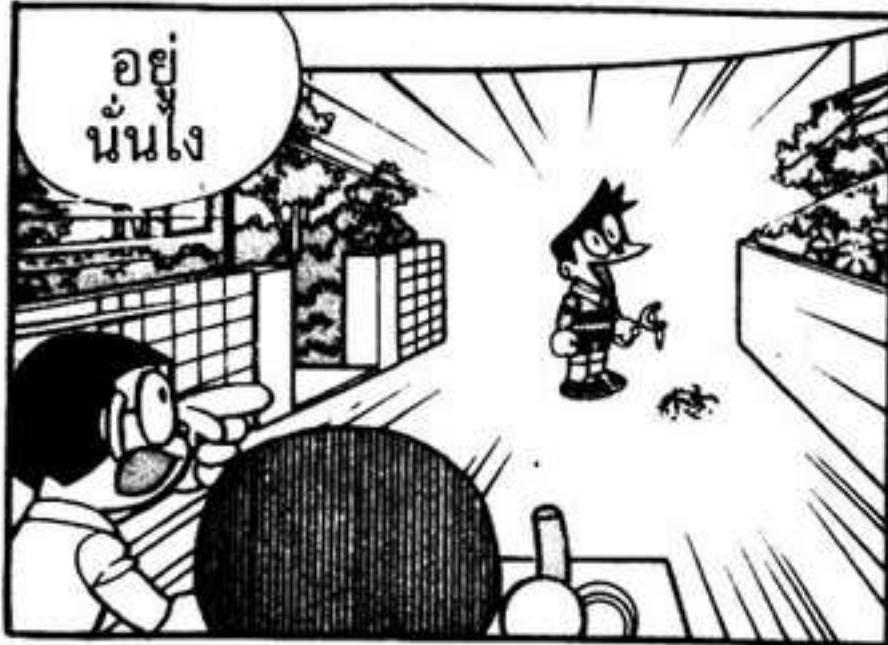



ยูเมโกะ นิจิตานิซัง

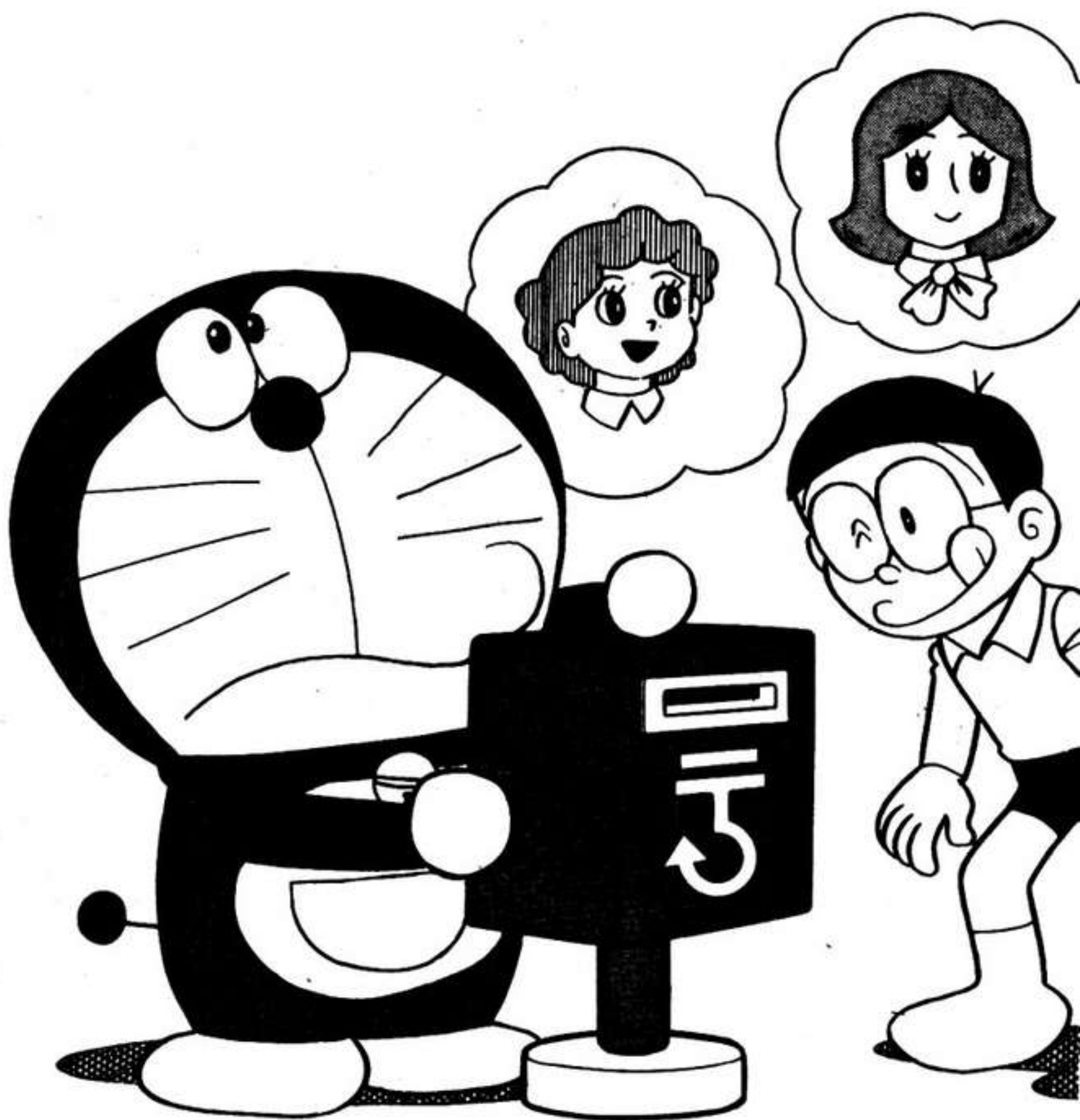

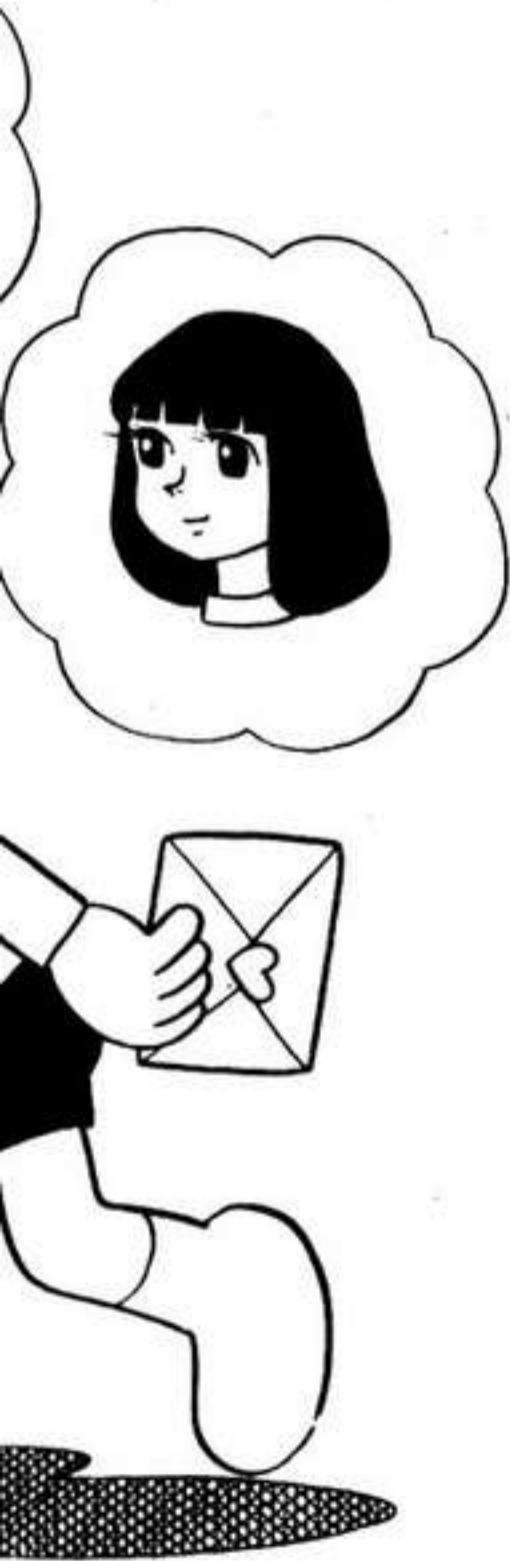



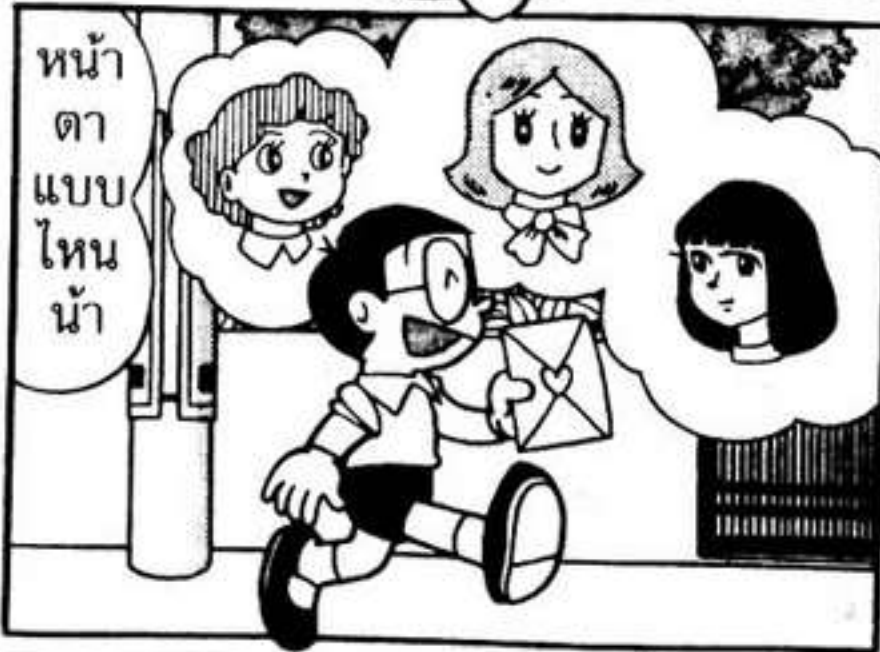

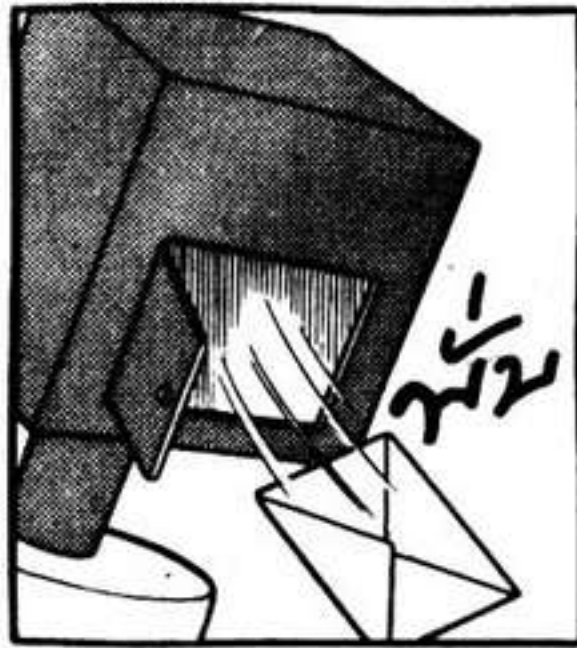
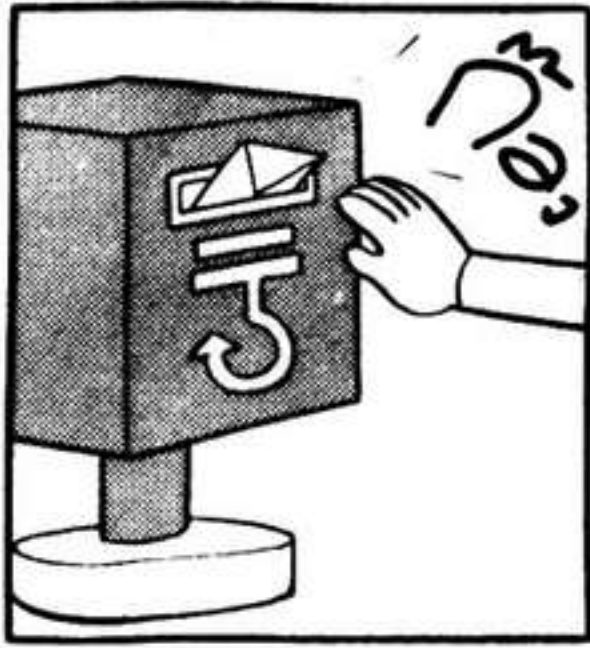







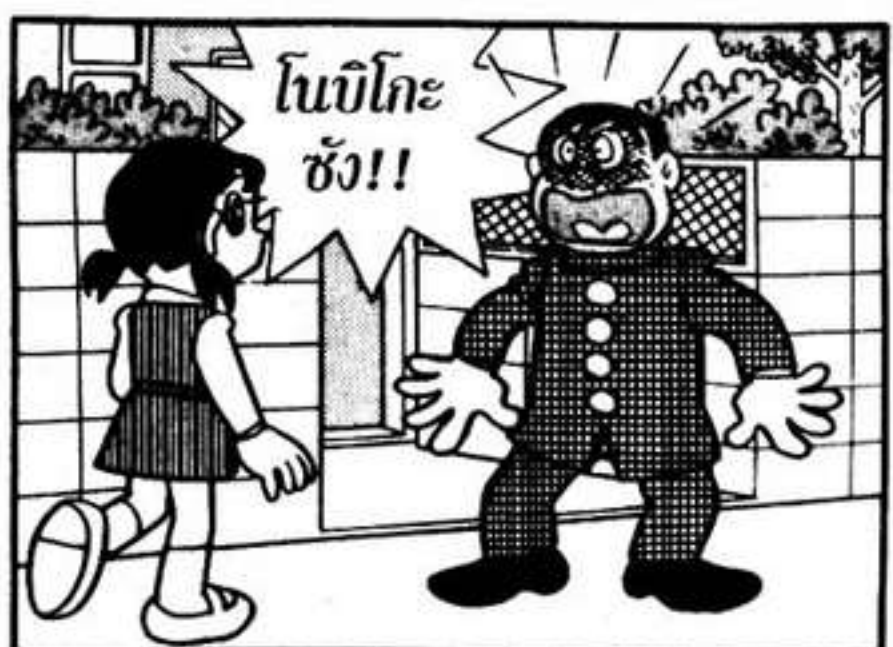

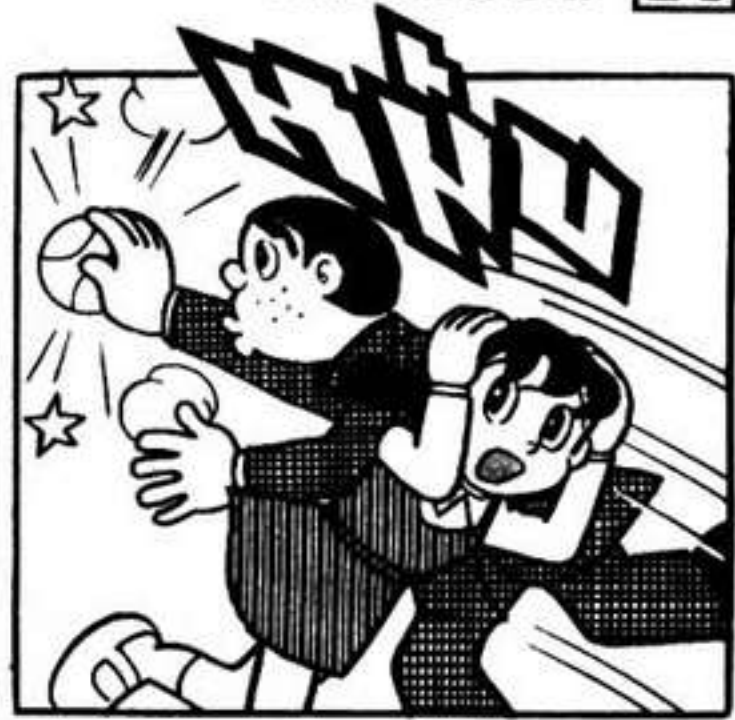

กระดิ่งเตือนอัคคีภัย













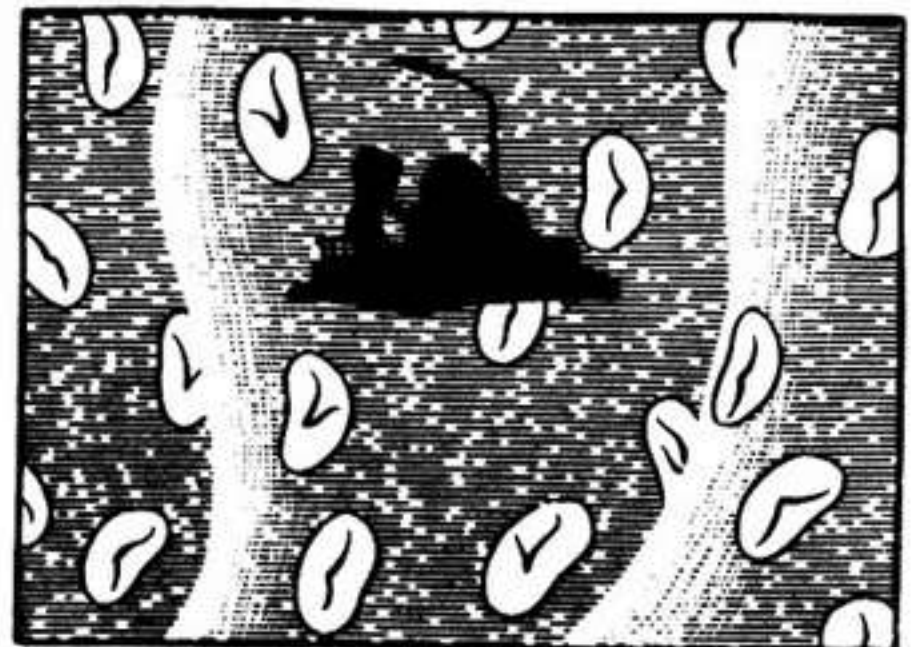
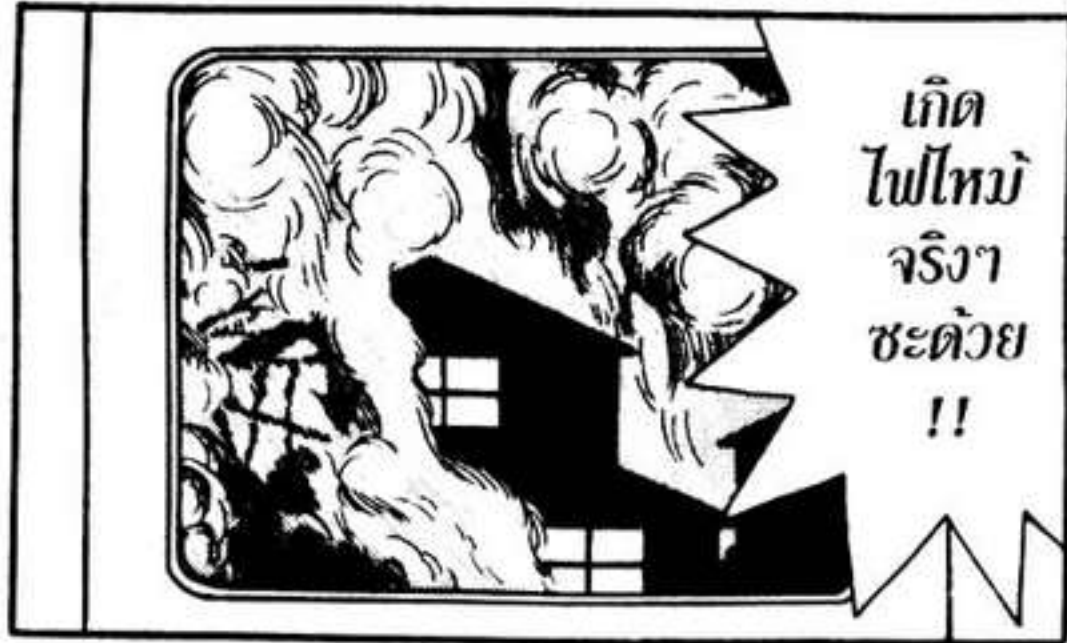



คืนนี้
ที่จะนอน
ก็
ไม่มี

ผมถึงได้บอก
ให้ระวังไง



ฉันไม่ได้ทำ
อะไรเลย ต้องมี
ใครมาเผาแน่



ไม่น่าเป็นยั้งนั้นนะฮะ
เพราะกระดิ่งบอกว่า
ลุงจะเป็นคนทำให้
ไฟไหม้....



นอกจากสุขบุรี
ระหว่างทางกลับบ้าน
ฉันก็ไม่ได้ใช้ไฟเลย



ตอนนั้น
ก็โม่ง
ครับ?

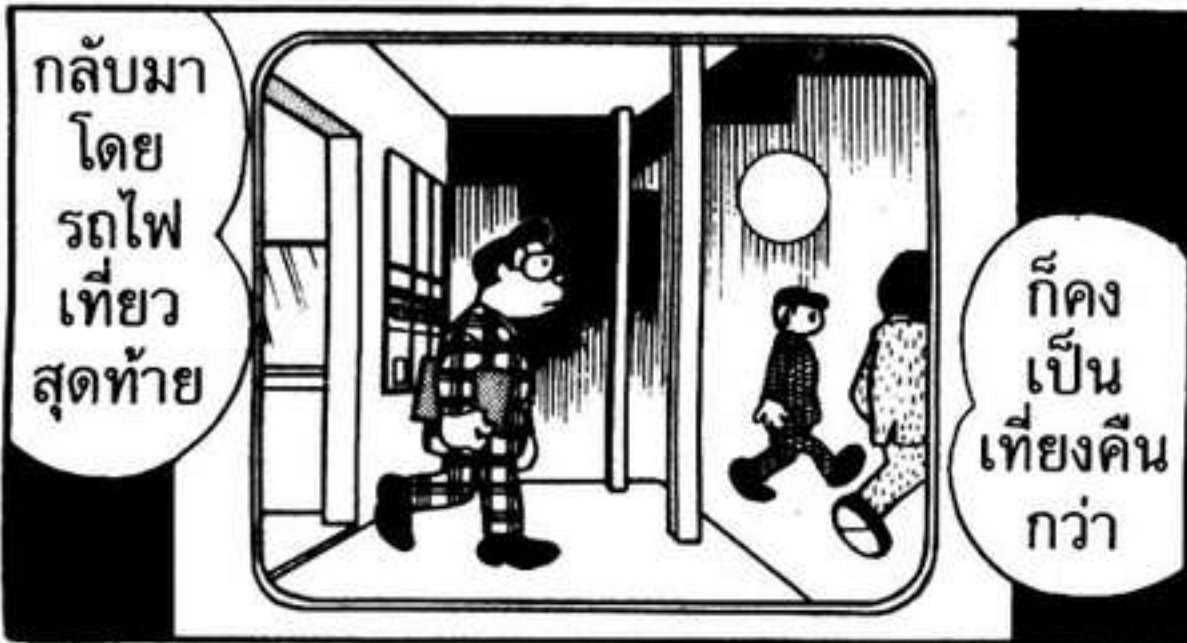

กลับมา
โดย
รถไฟ
เที่ยว
สุดท้าย

ก็คง
เป็น
เที่ยงคืน
กว่า



ตอนนั้นยังไม่ได้
สุขบุรีเลย



คายหมาก
ฝรั่งที่
เคี้ยวตอน
อยู่บน
รถไฟทั้ง

แล้วก็
จุด
บุรี



อะฮ่า
.....

ทั้งบุรีนี้
ไปทั้งที่ไฟ
ยังติดอยู่
ใช้มั้ยฮะ





ขุนนางศตวรรษที่ยี่สิบ



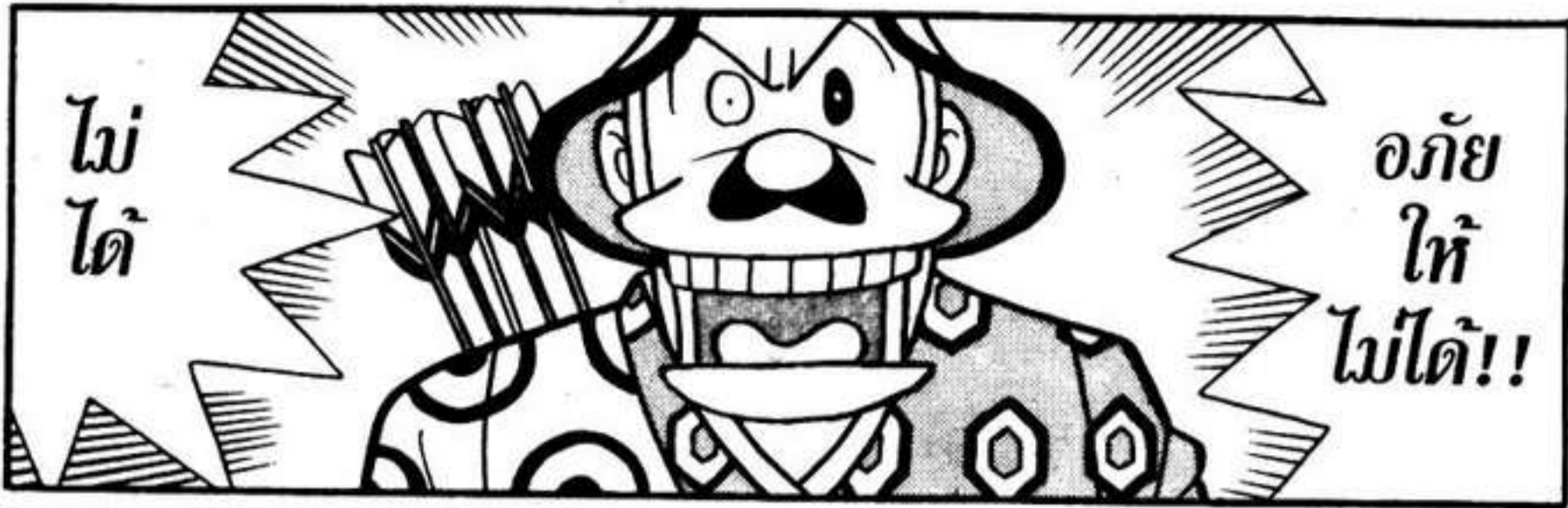





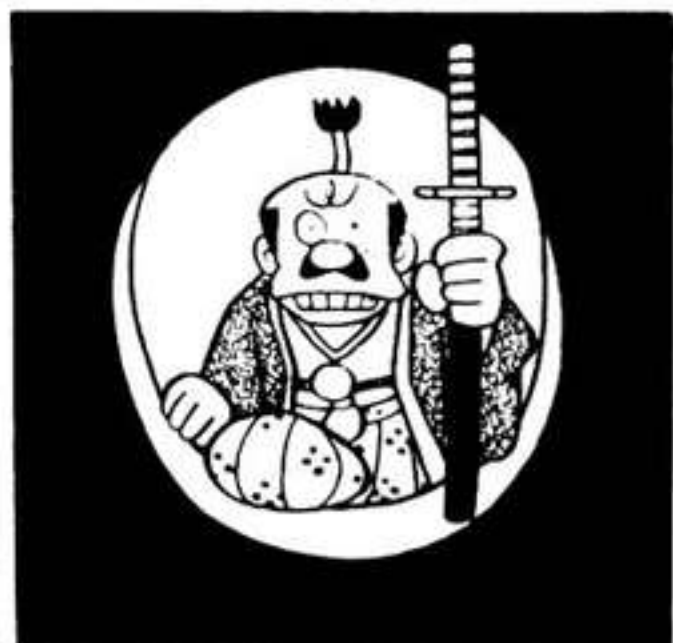
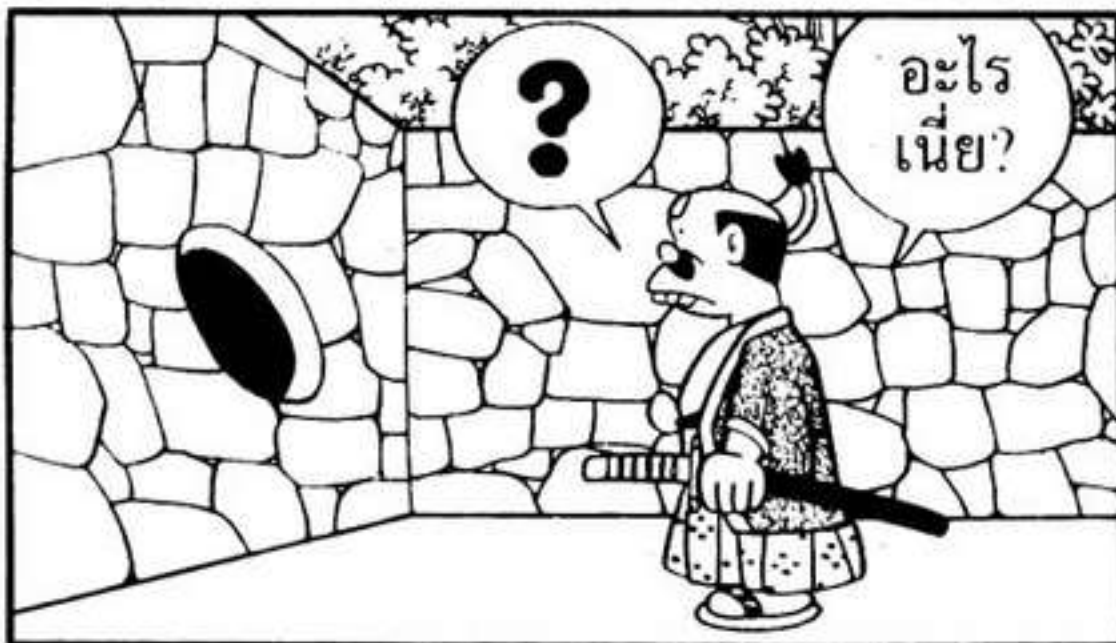

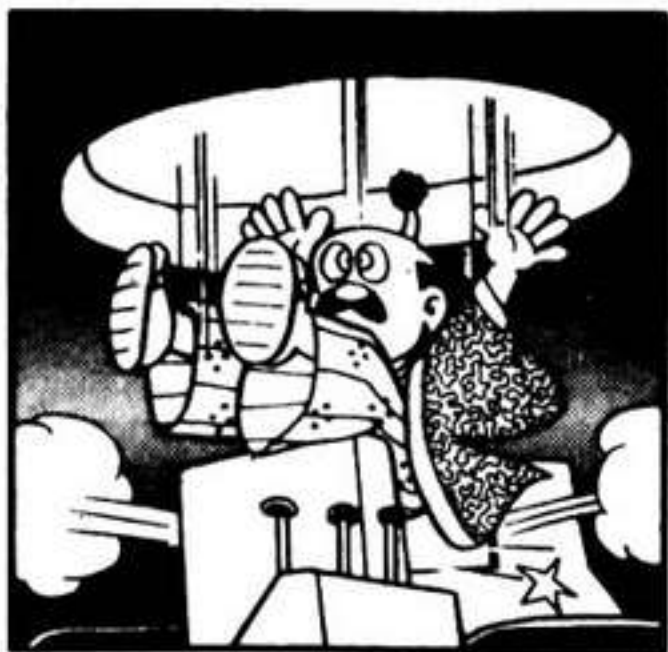

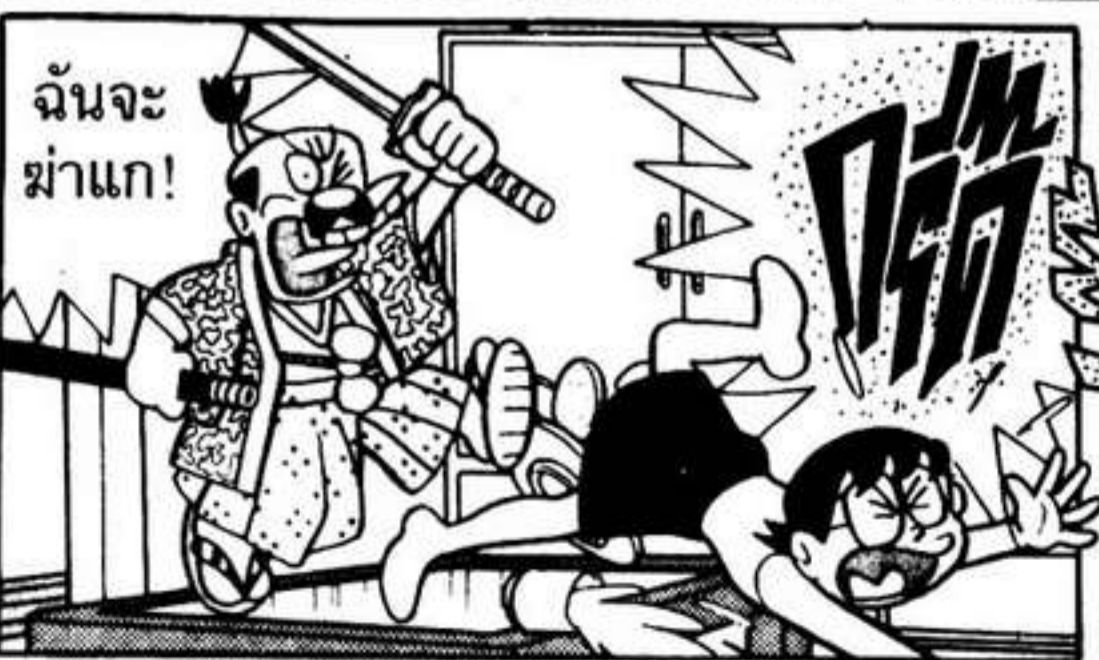

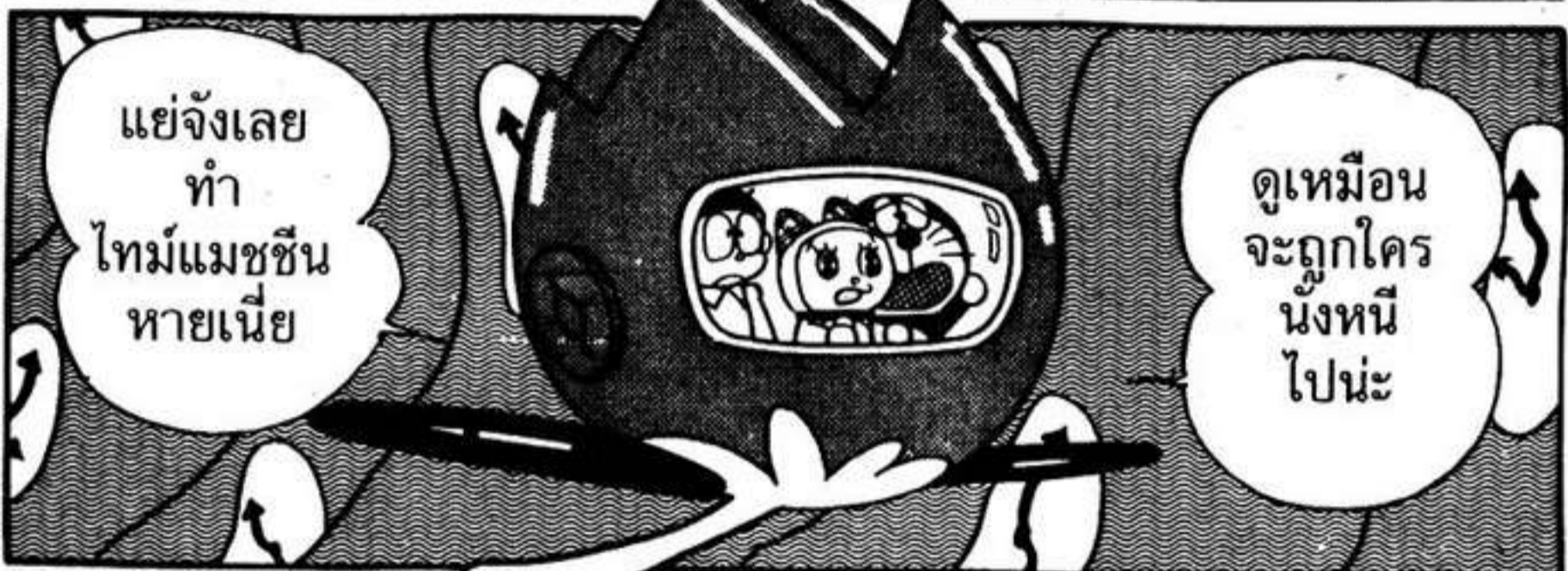

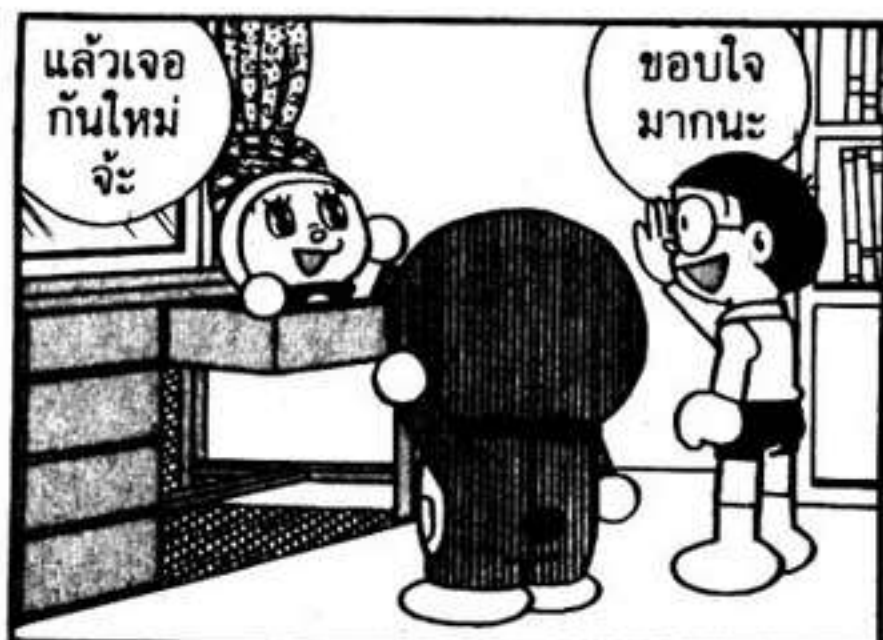







กลืนสร้างแดน



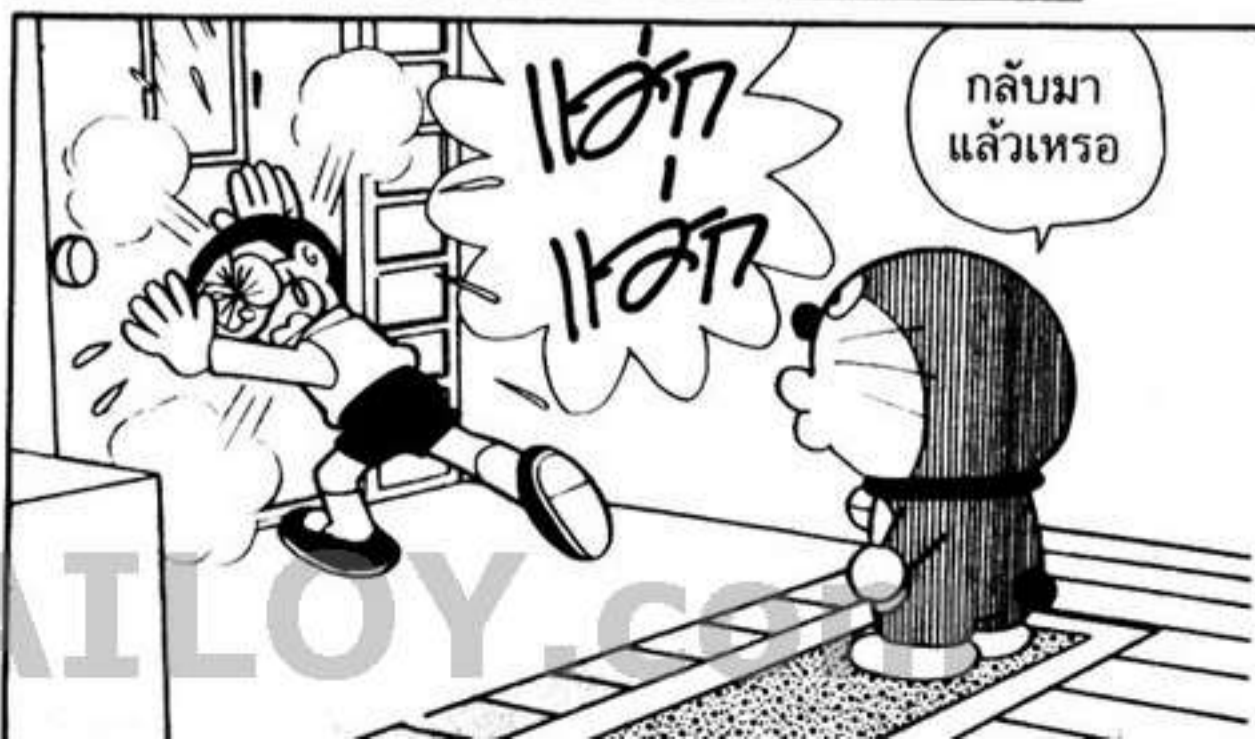
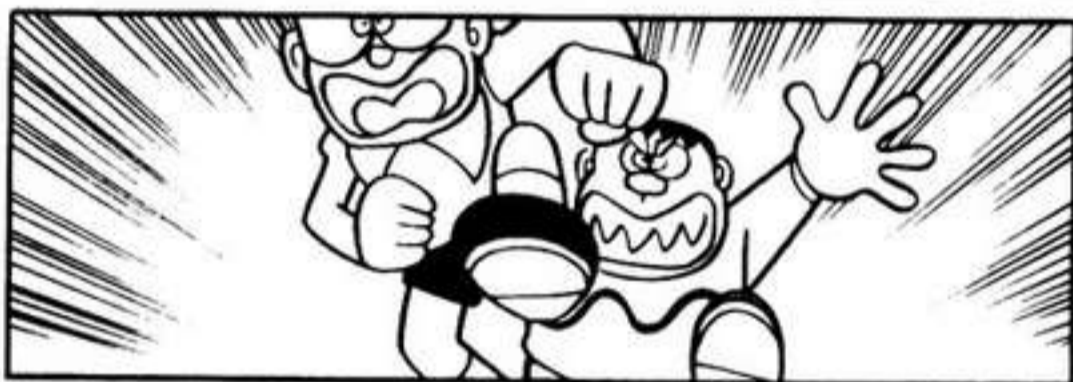
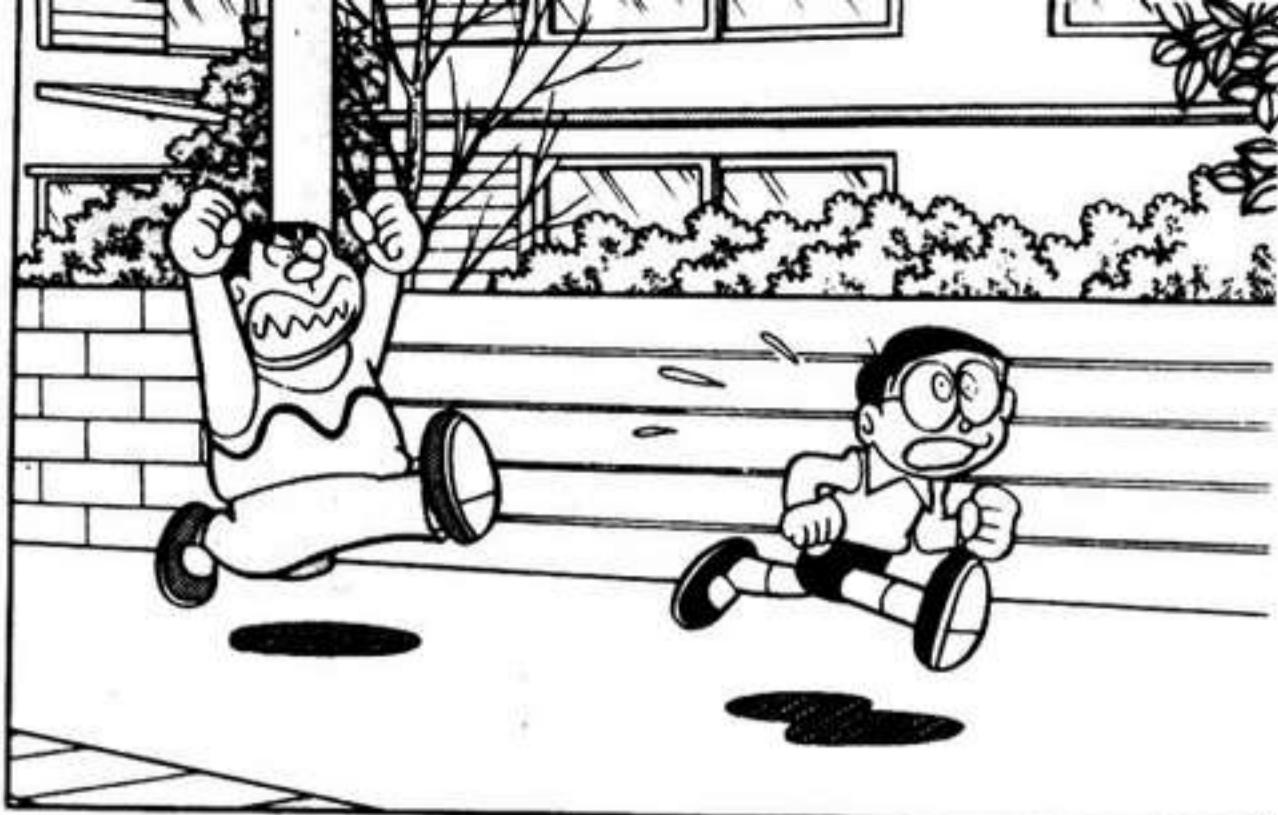

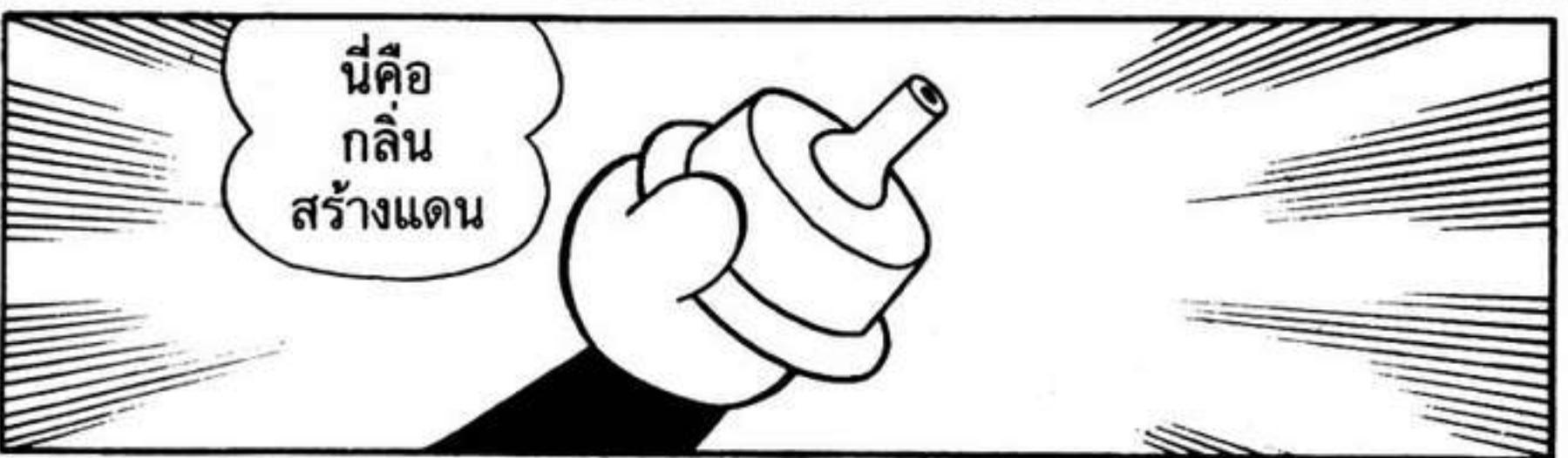



ถ้าหยุด
ไปที่
ละหยุด



ส่วนที่ล้อม
เป็น
สี่เหลี่ยม

จะกลายเป็นแดน
ของตัวเอง



รีบลอง
หยุดดู
ดีกว่า....



รดไปที่โคน
ของสิ่งที่
เหมือนเสา



ไม่เห็น
ออก



ต้องติด
ไว้ที่นี่....



ทำไมต้องให้
ทำทำยังงี้
ด้วยเล่า...

ก็มันประดิษฐ์มา
แบบนี้เนี่ย



จากหยุดต่อหยุด
ถ้าเกิน 10 เมตร
จะไม่มีผล...



รดไว้ที่เสา
4 ด้าน
แล้ว...

แค่นี้ ห้องนี้
ก็เป็นแดน
ของนาย





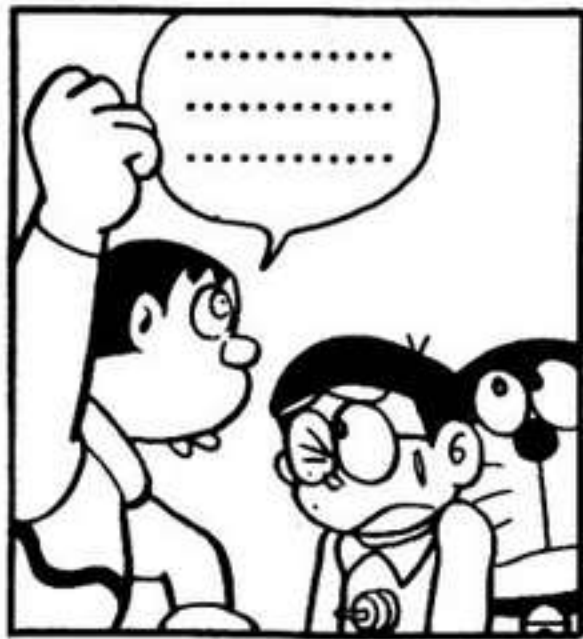



ฟาร์มขนม

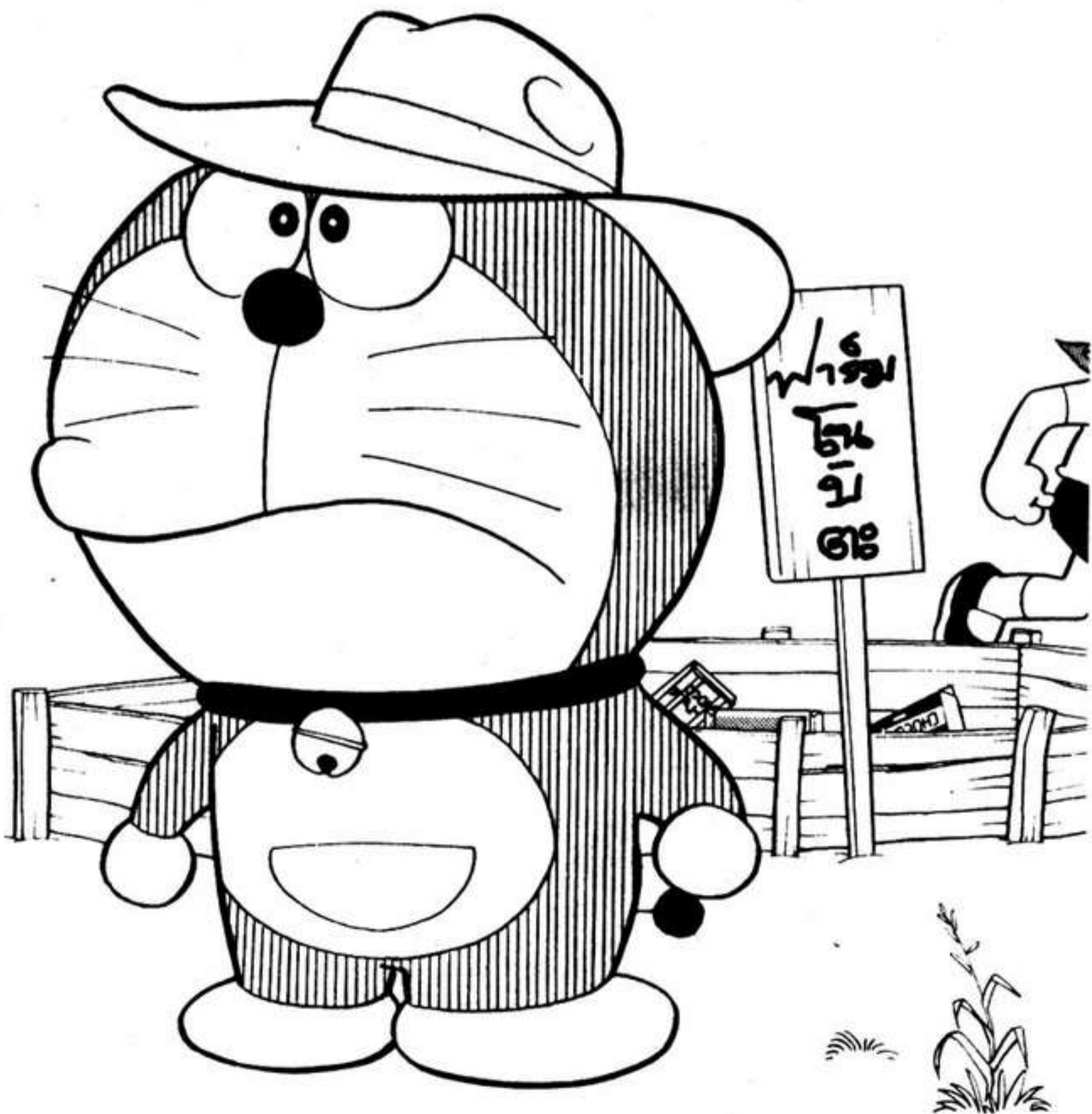





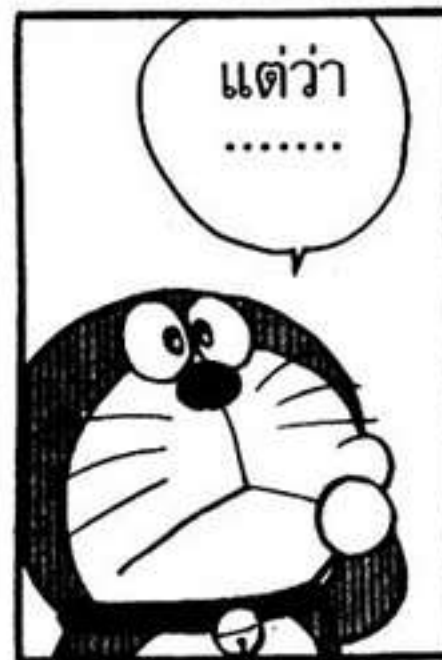

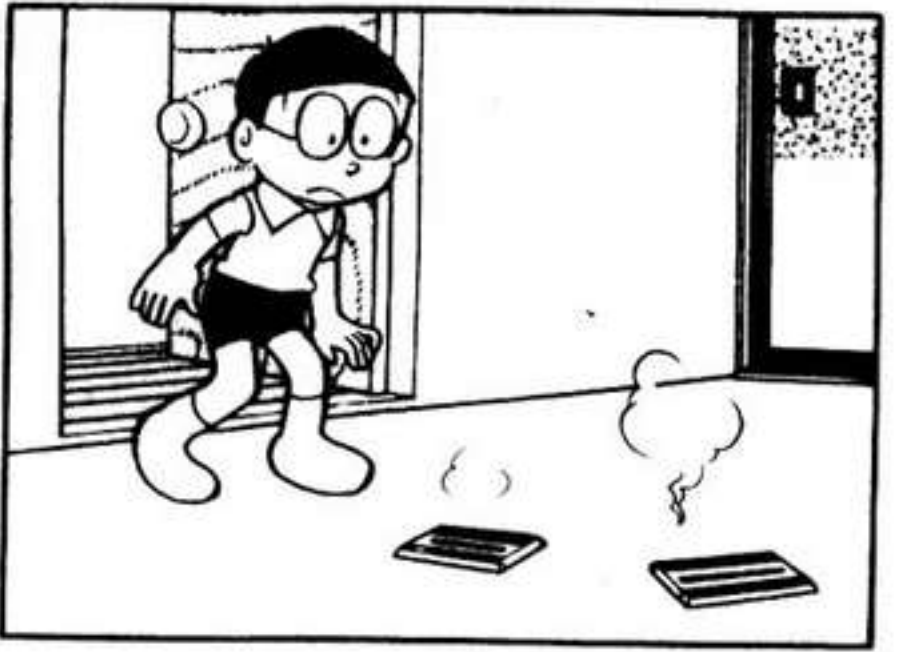

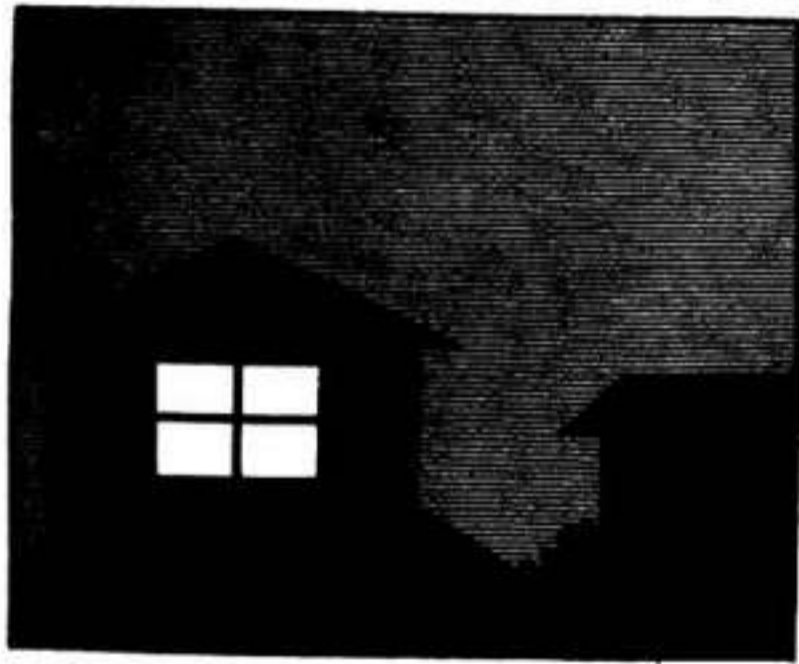





ท้าว ?

เฮ้อ
ง่วงจัง

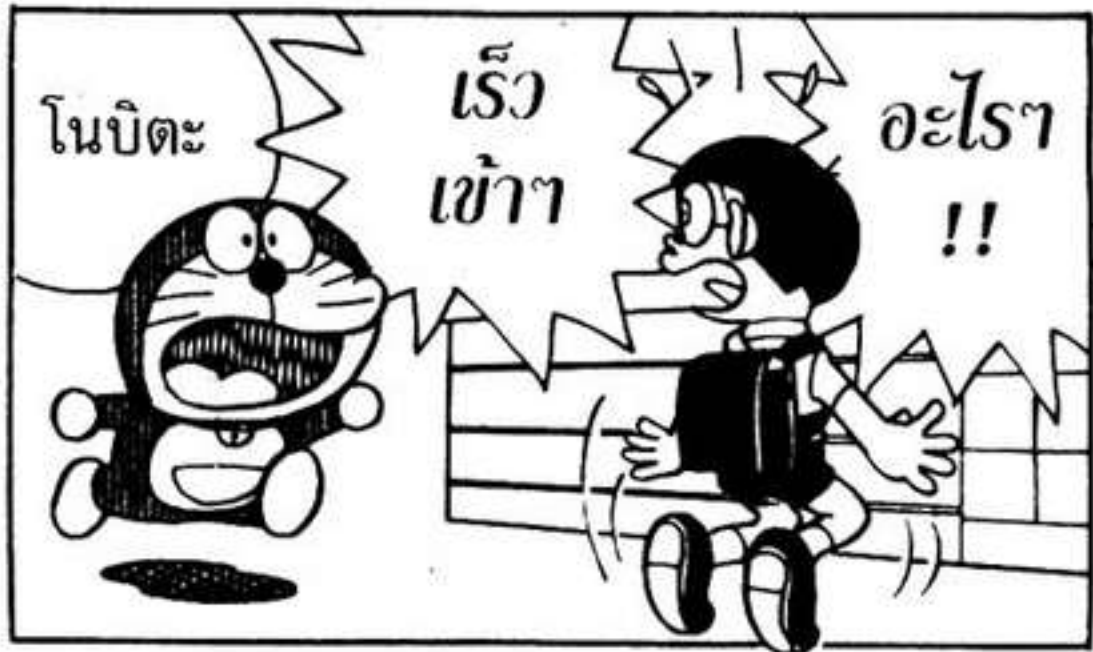

โนบิตะ

เร็ว
เข้าๆ

อะไร
!!



ช็อกโกแลต
ออกลูกมาแล้ว
เหรอ!?

เฮ้อ

โชโย
!!



เพื่อไม่ให้
มดตอม
พ่นยาไว้
ดีกว่า

ถ้าฝนตก
เข้ามาอยู่
ในนี้ล่ะ
ไม่มันจะ
ละลาย
ไปเลยนะ



ที่นั่นมี
อะไรนะ

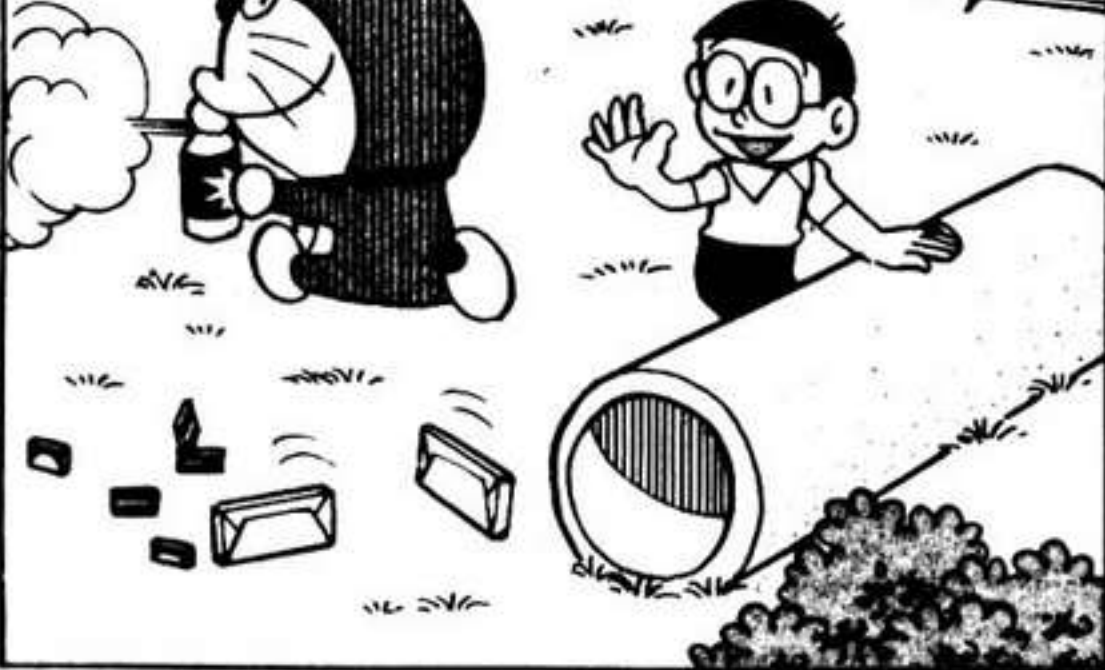

ไม่มี
อะไร

ว้าก!!
อย่าเข้า
มานะ



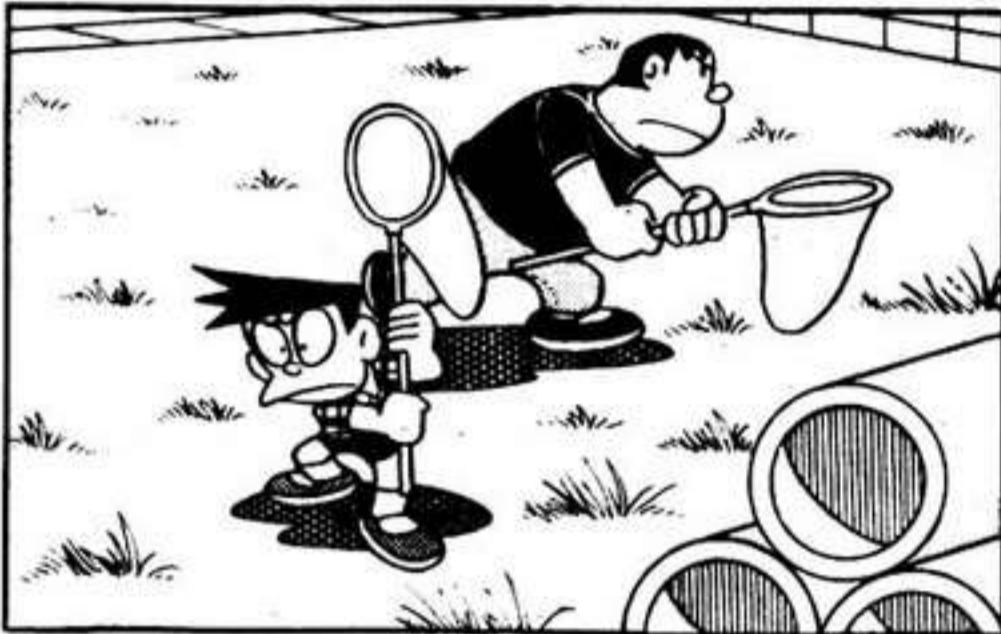



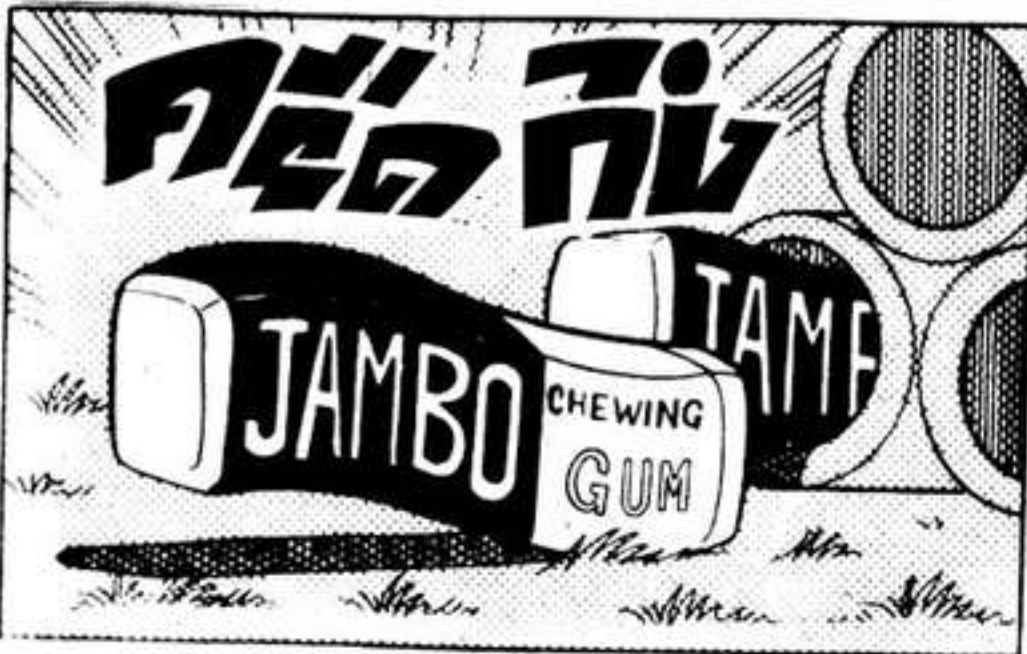

เวลา ช่วยเดินไปที่!!

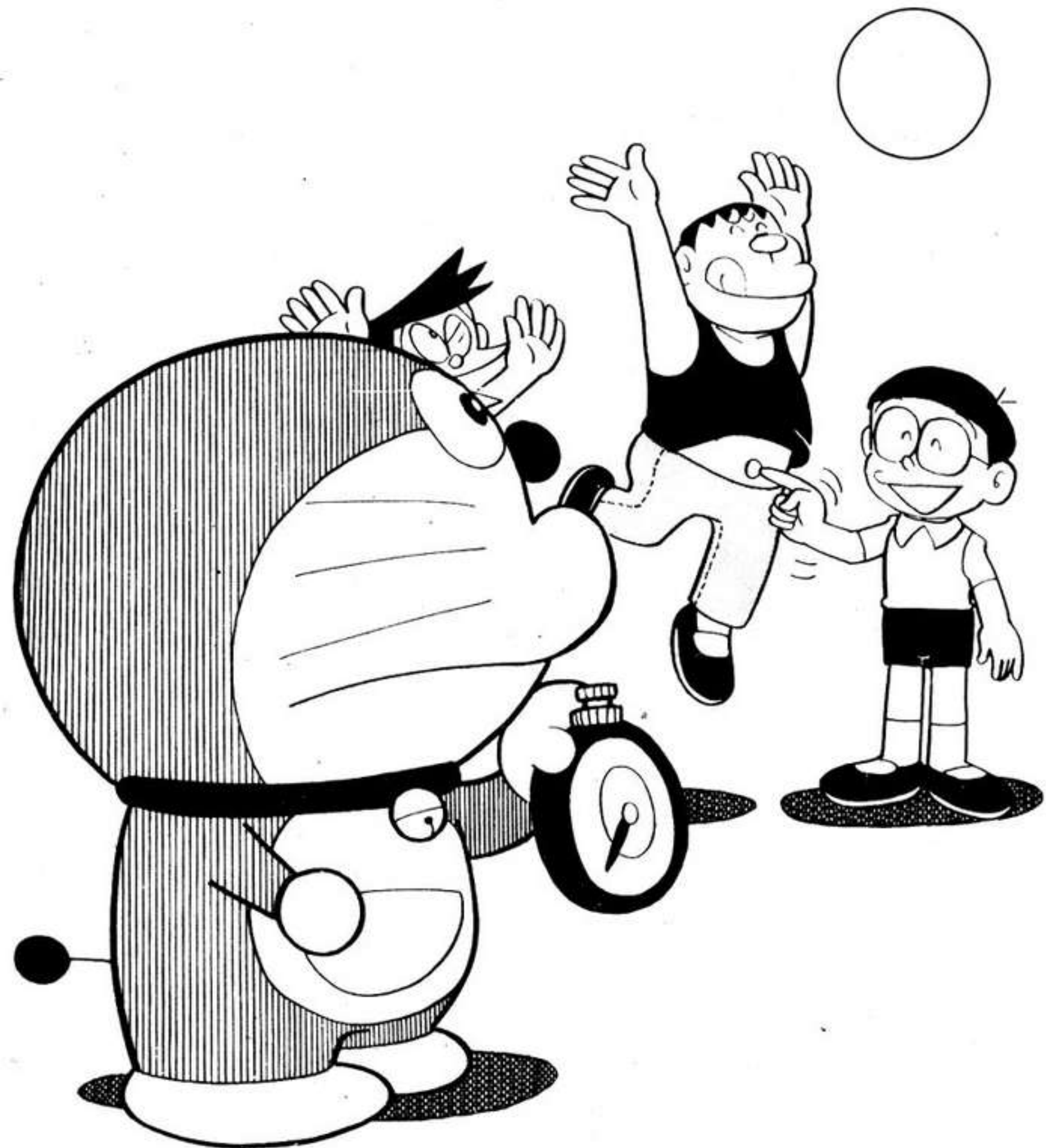



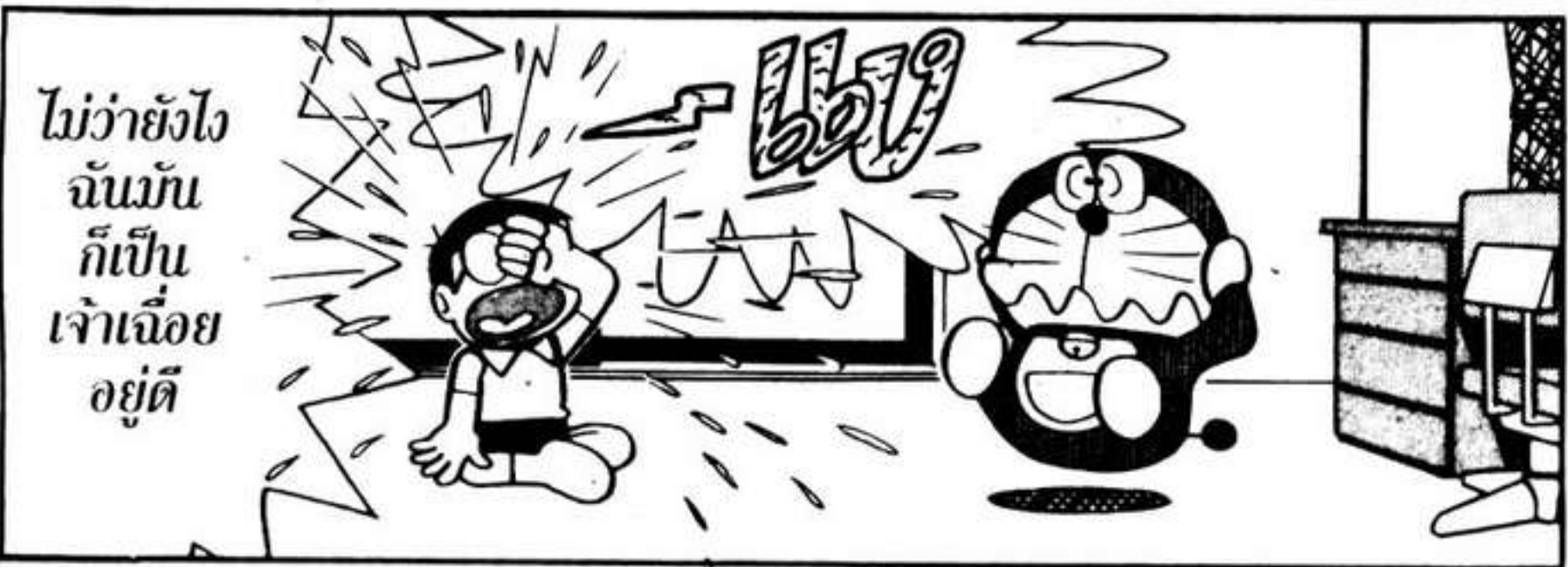

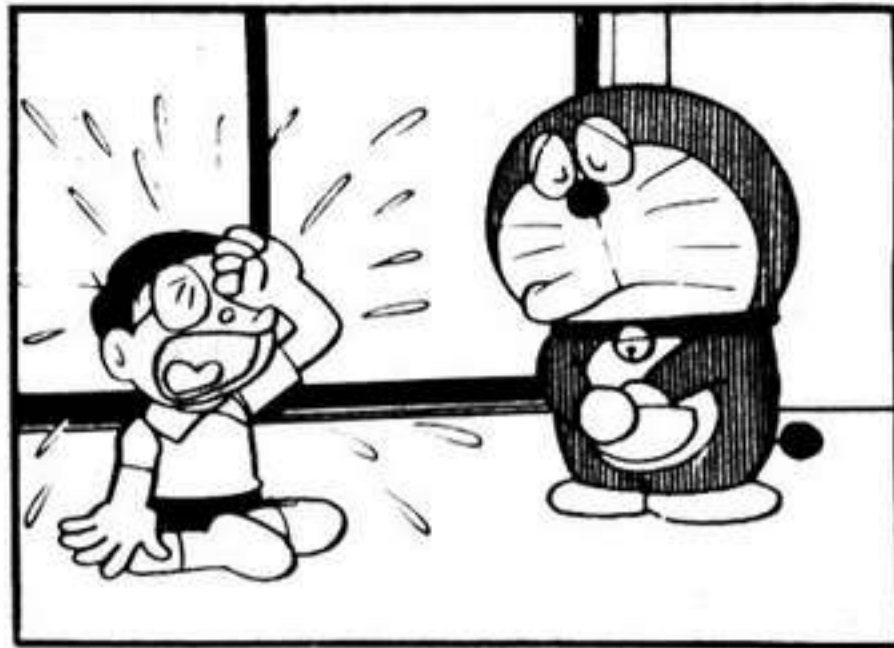

“นาฬิกา
ขอเวลา
นอก”

เอาไว้ใช้
หยุด
เวลานะ



คลิก

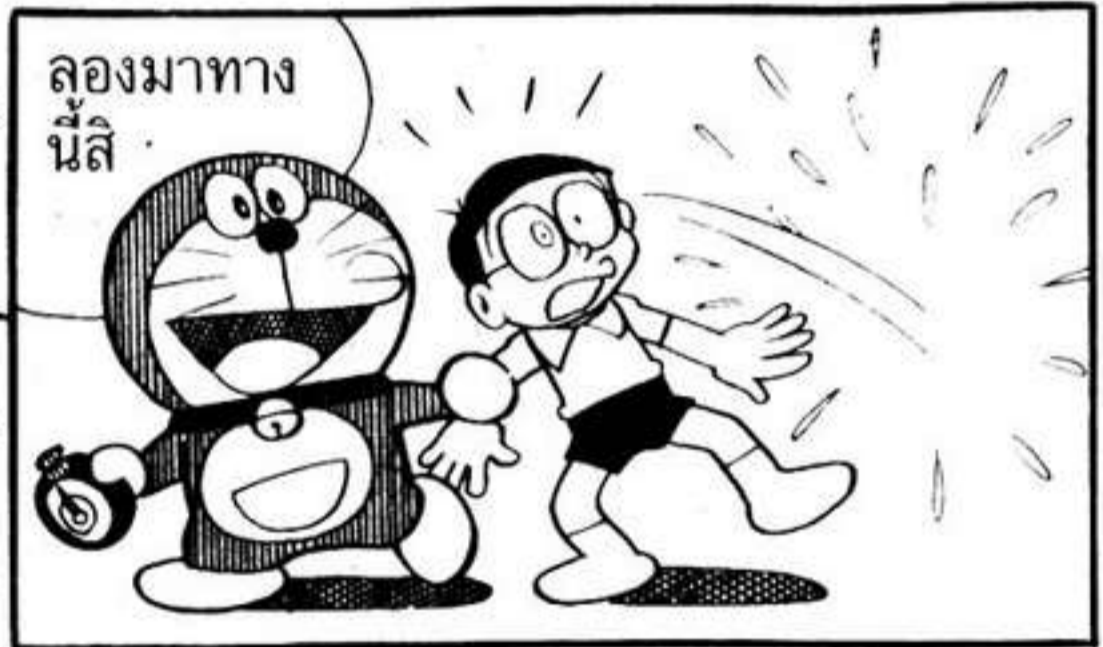

ลองมาทาง
นี้สิ



น้ำตา
หยุดกลาง
อากาศ



ทั่วโลก
หยุดหมด
เลยแหละ



จริงด้วย
แม้แต่ลม
ยังหยุด



ทั้งดวงอาทิตย์
ทั้งโลก
ไม่ขยับ

ตราบเท่าที่นาย
ยังไม่ได้กดปุ่ม
นาฬิกาอีกครั้ง
นึ่ง...



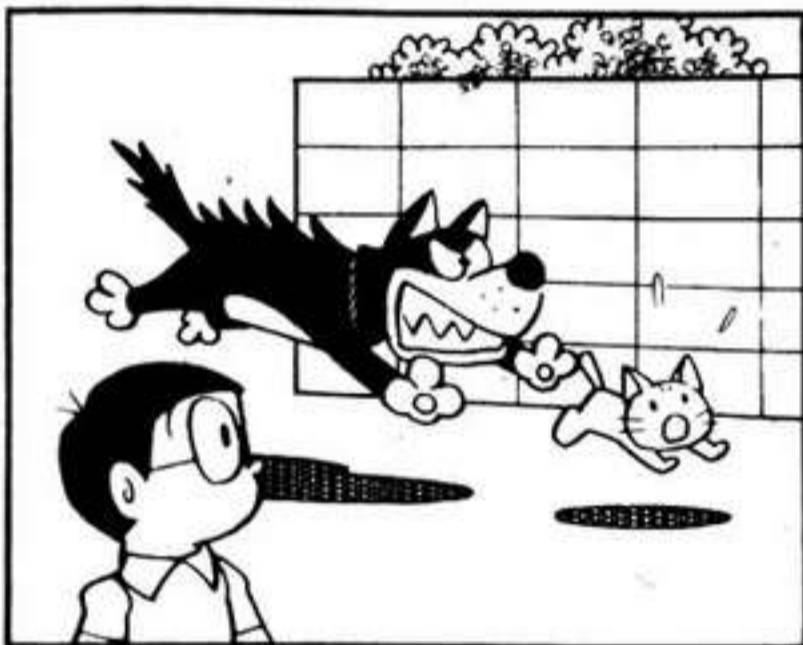

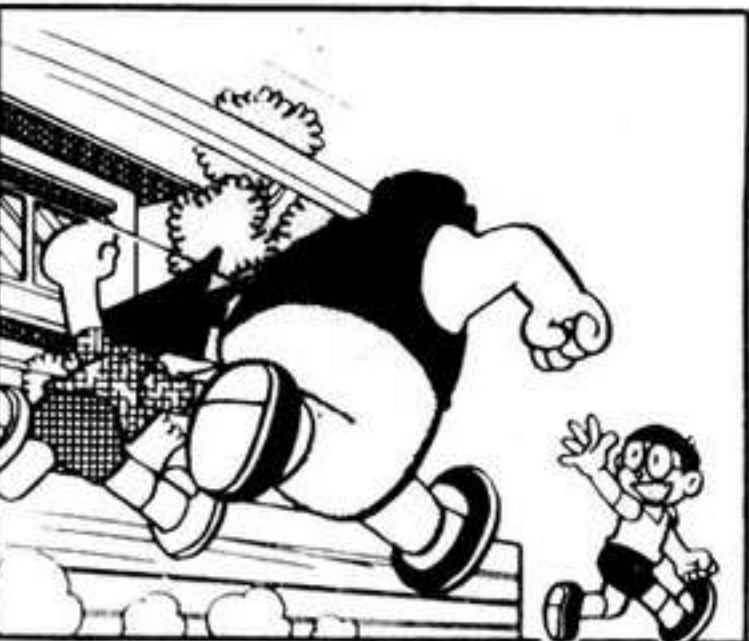
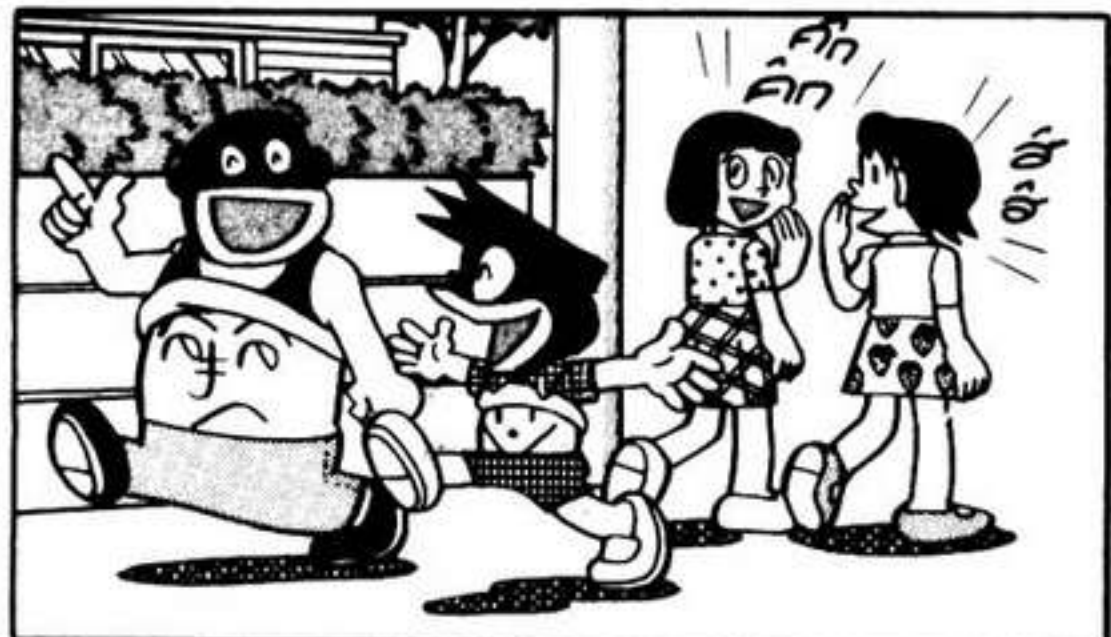
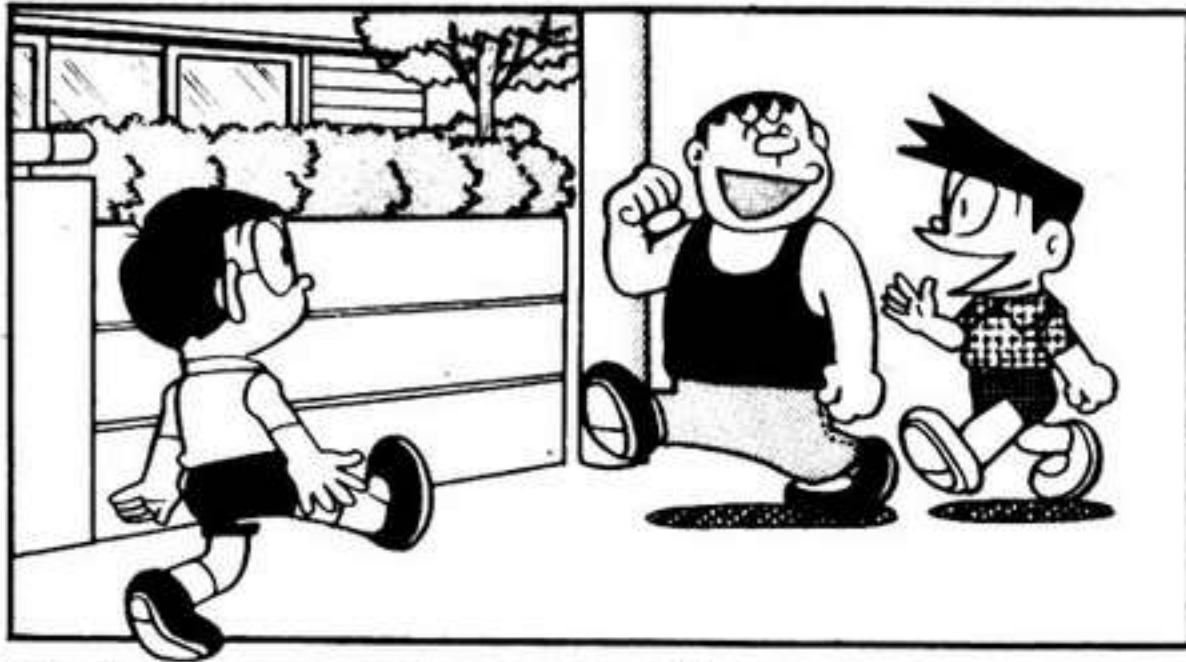



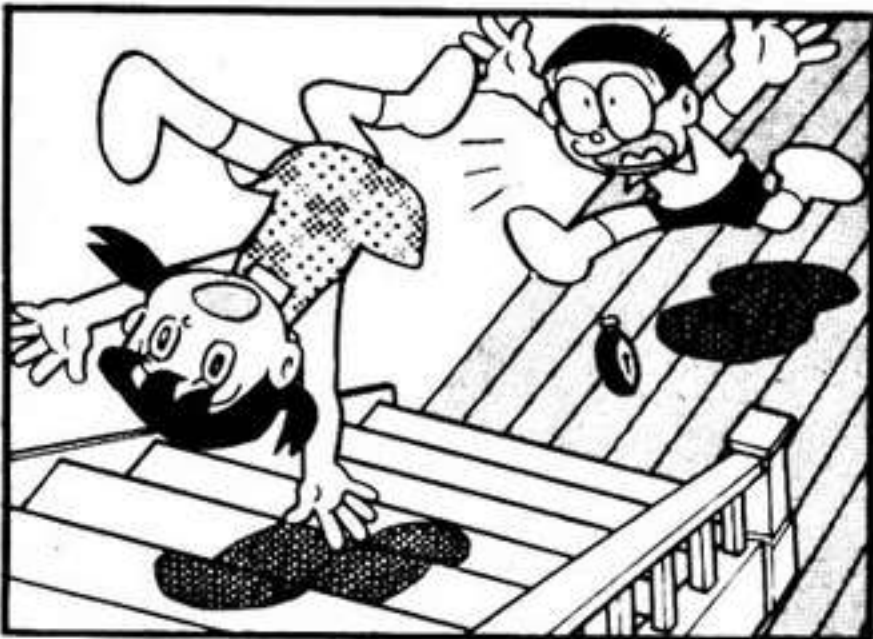





จริงสิ
กลับไปตอน
ก่อนเวลา
จะหยุด

ให้
โดราเอมอน
ที่ยัง
เคลื่อนไหว
ได้ซ่อมให้
ดีกว่า



ใช้แกลังคน
สนุกๆ
ได้นี่

ห้ามใช้
แกลัง
คนนะ



โดรา
เอมอน

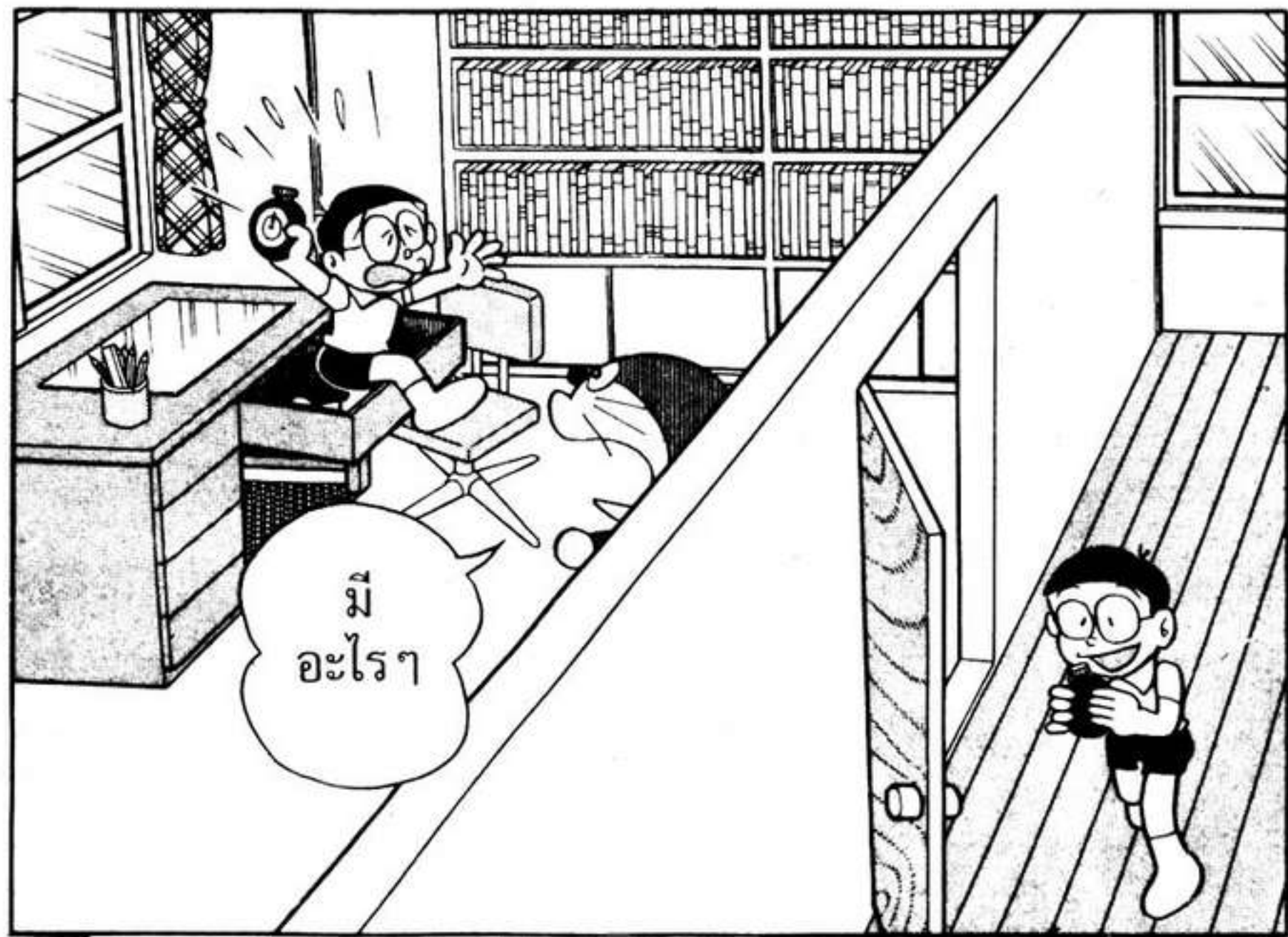

มี
อะไรวะ

เครื่องส่งของที่ลืมหิ้วไว้

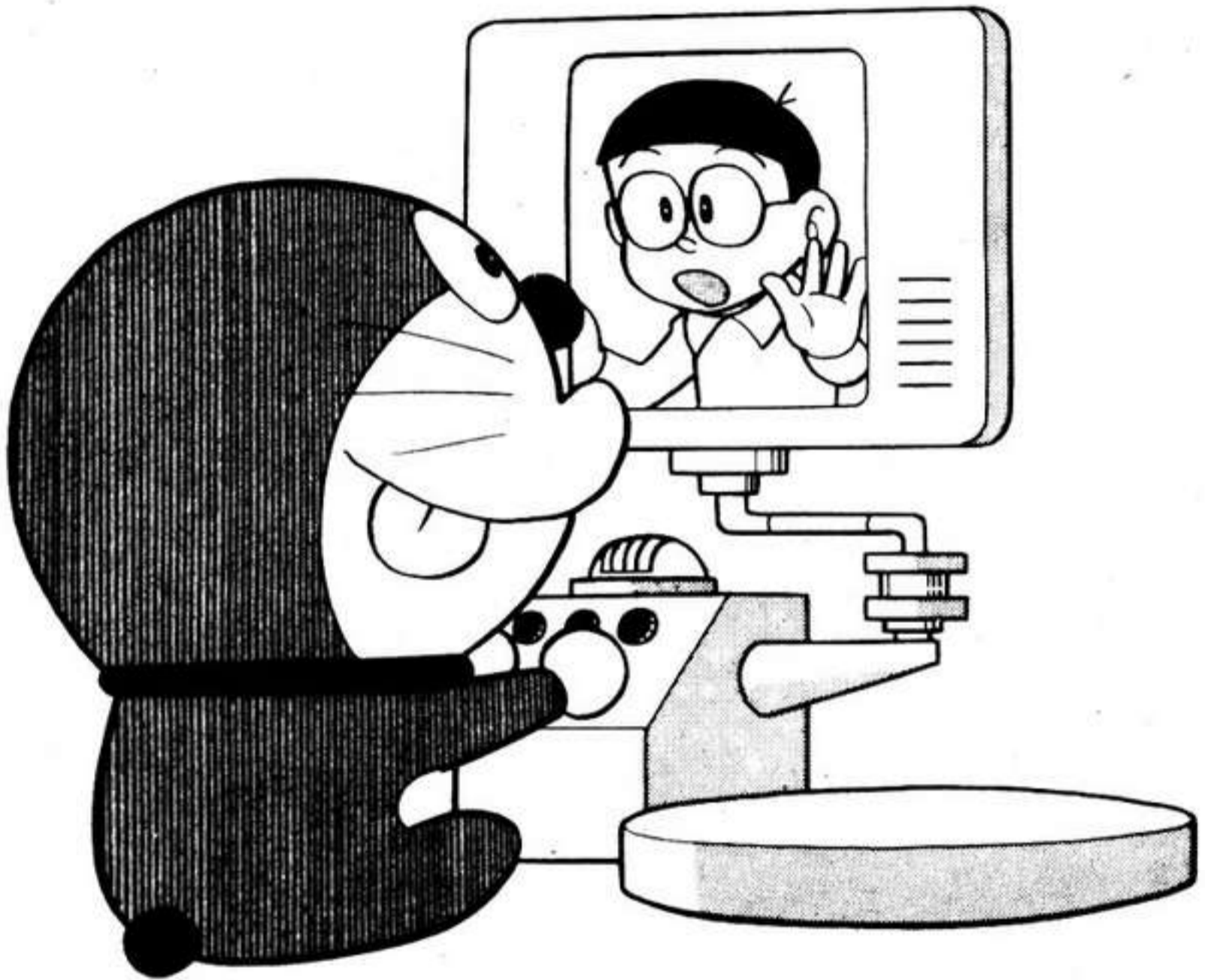

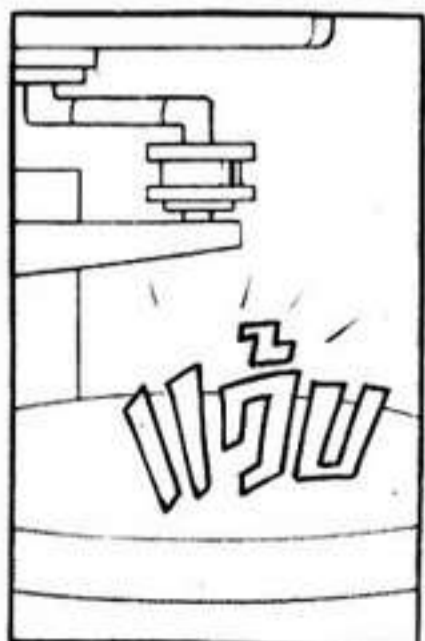
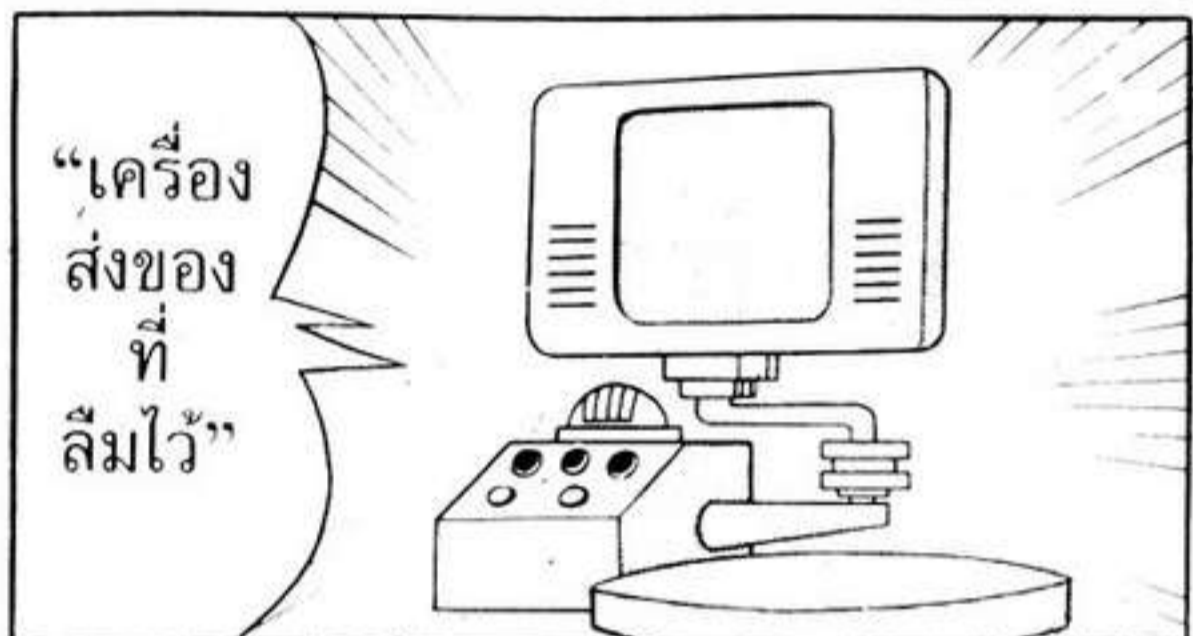







ซีเนะโอะซัง
เล่นกลเก่งจังเลย



คนที่ทำได้
ยั้งคงมี
ฉันคนเดียว
มั้ง



อะไรกัน
เล่นกลแค่นั้น
ทำเป็น
อวด



จริง
สิ

ถ้ามีเครื่องนี้
ฉันก็เล่นได้
นี่นา



นะ นะ
ขออภัยนะ

ยุ่งยาก
จัง



ทำให้ซีซัง
กับซีเนะโอะ
ตกใจเล่น
ดีกว่า



ฉันเล่นกล
เก่ง
กว่าอีก



รีบทำ
ให้ดูเลย

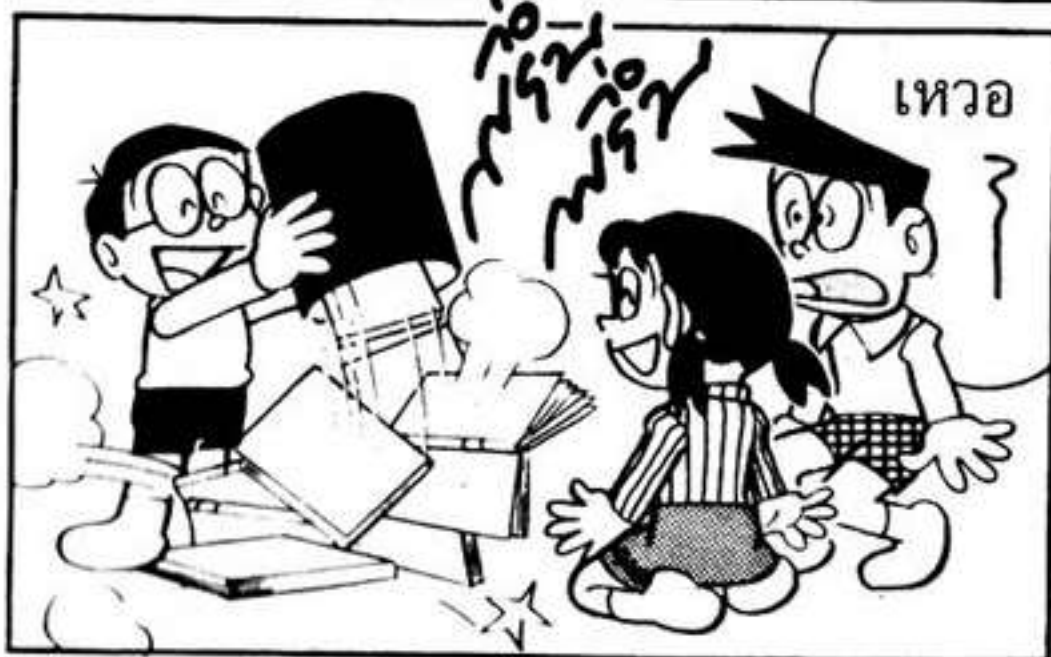
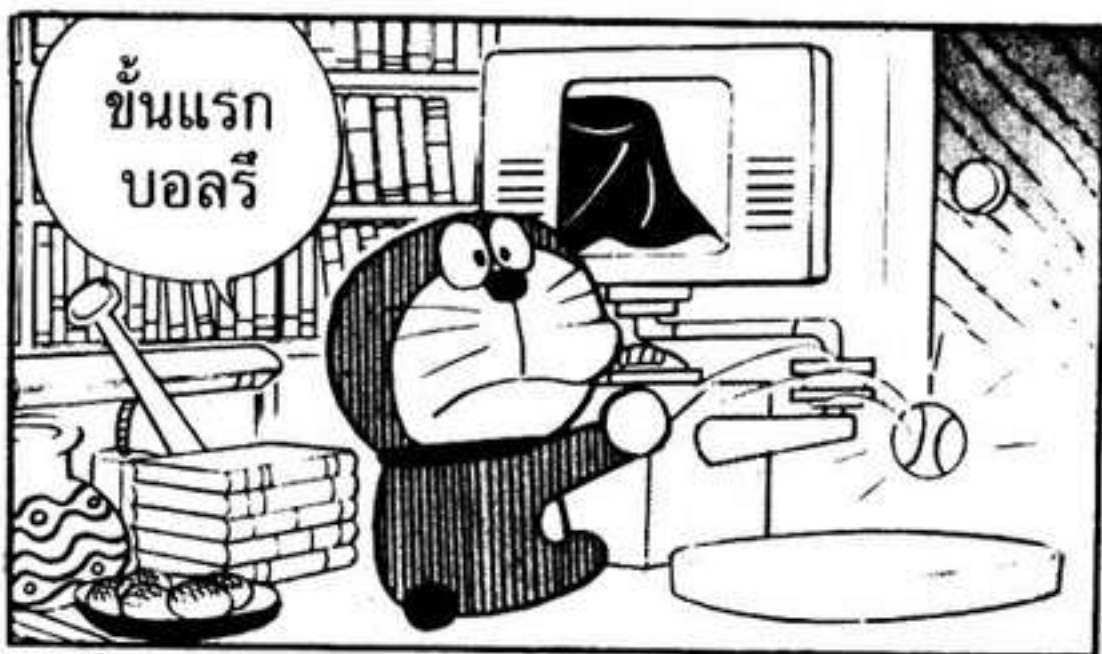



แผ่นดิน ลงใต้ดิน





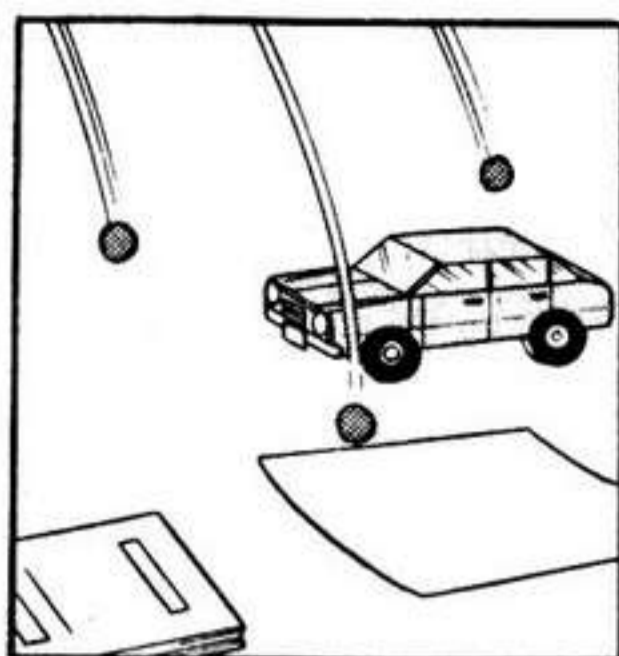
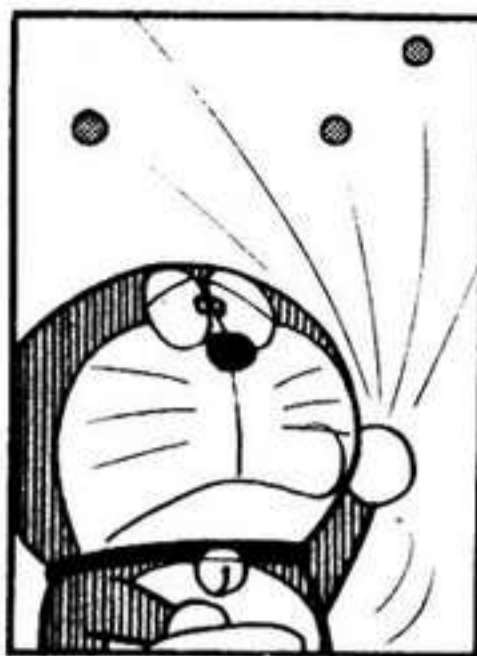

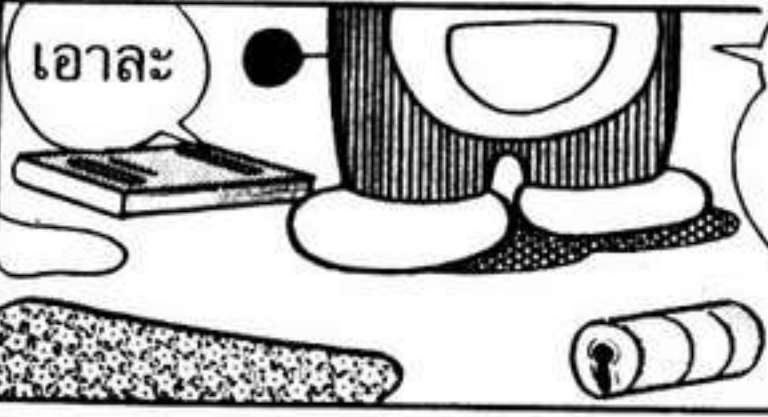
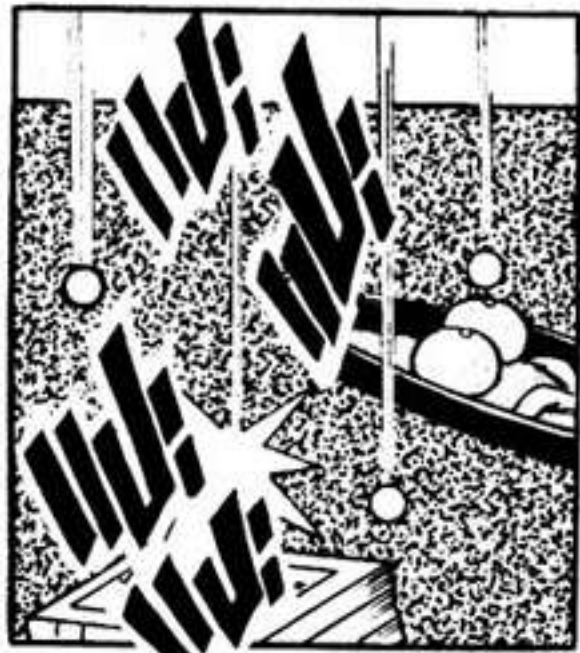



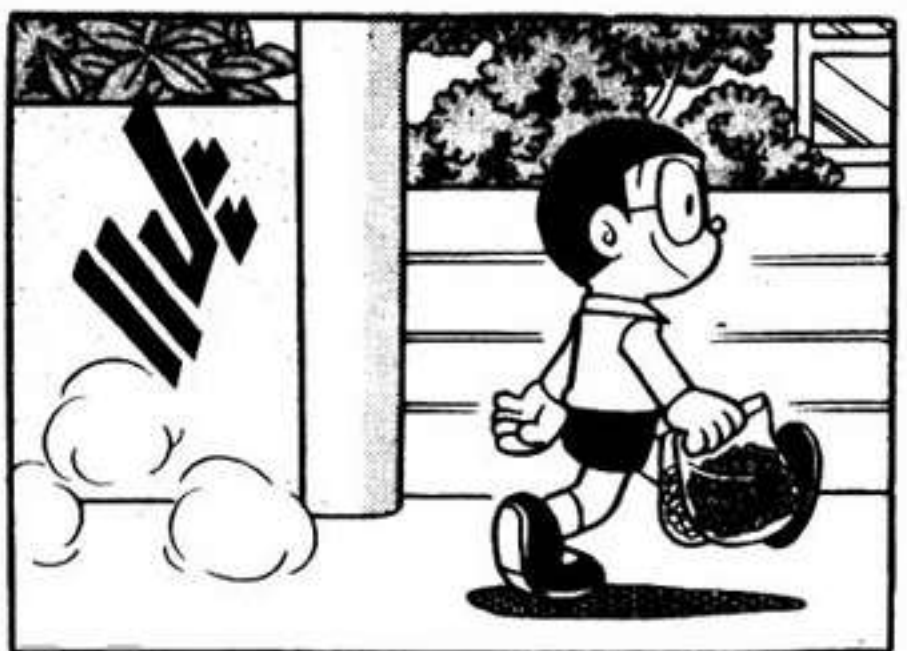
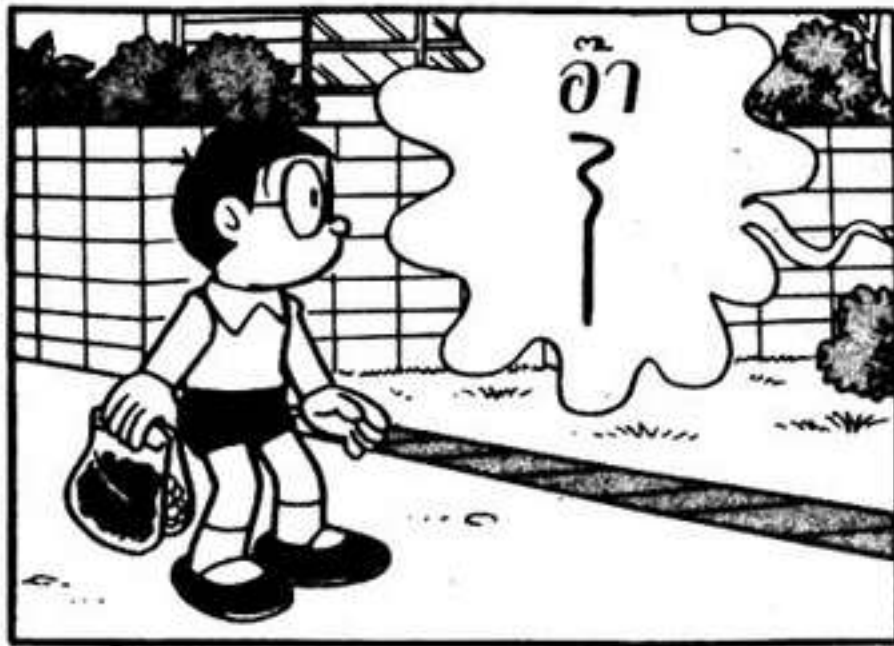

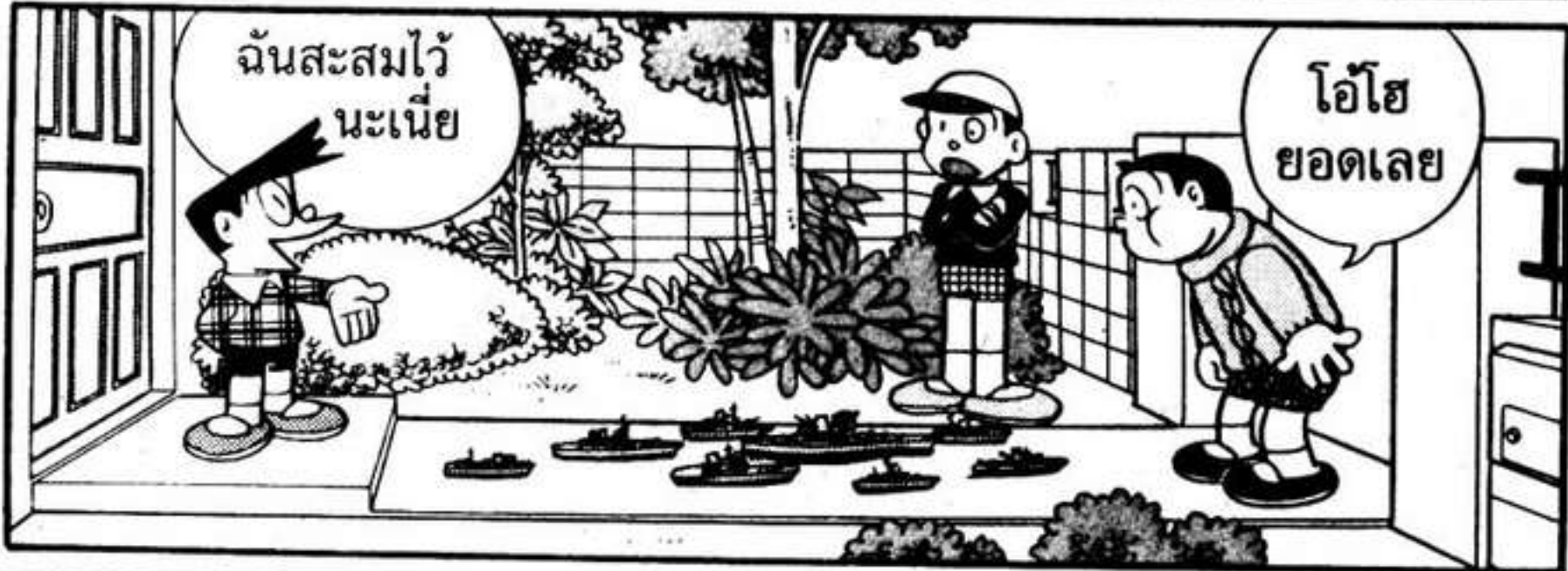

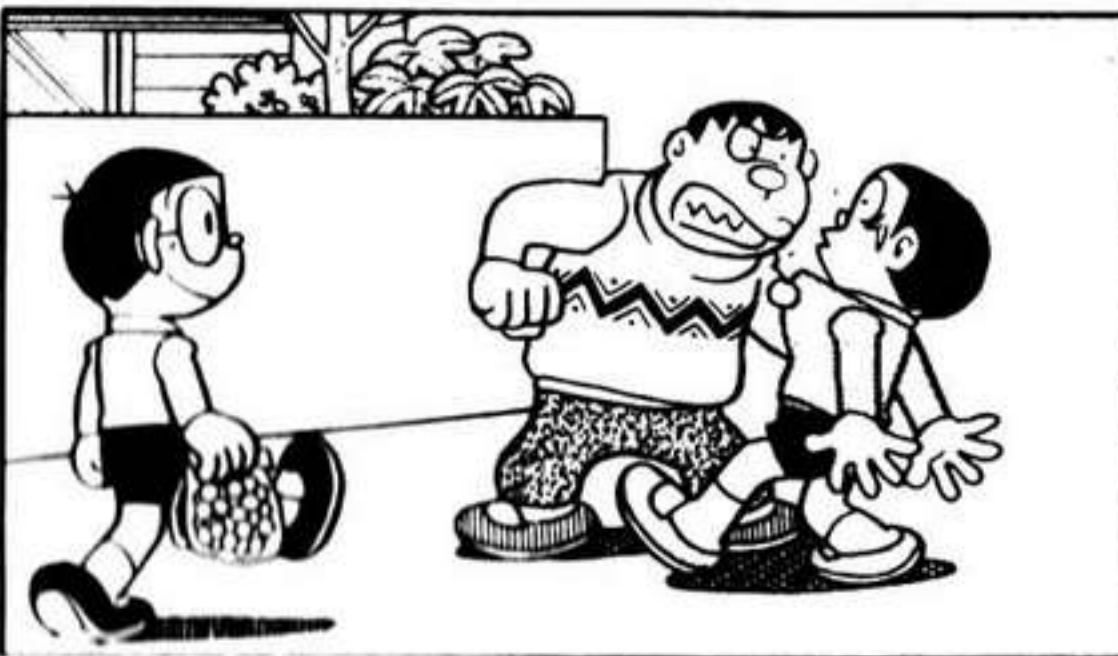
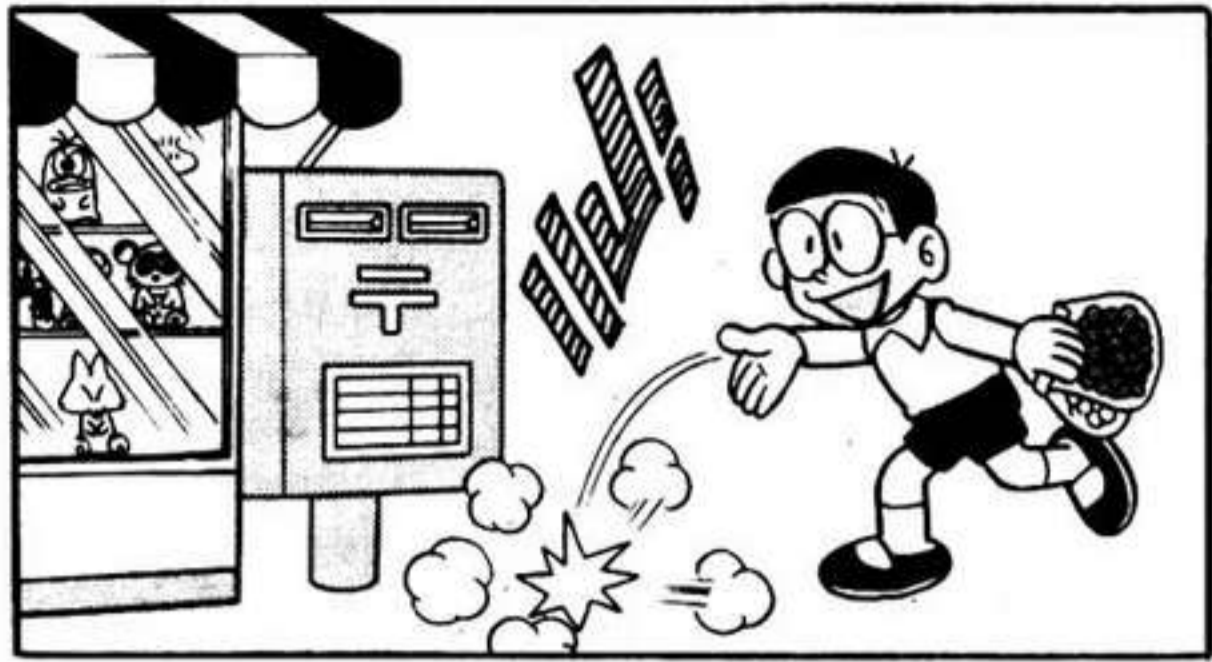

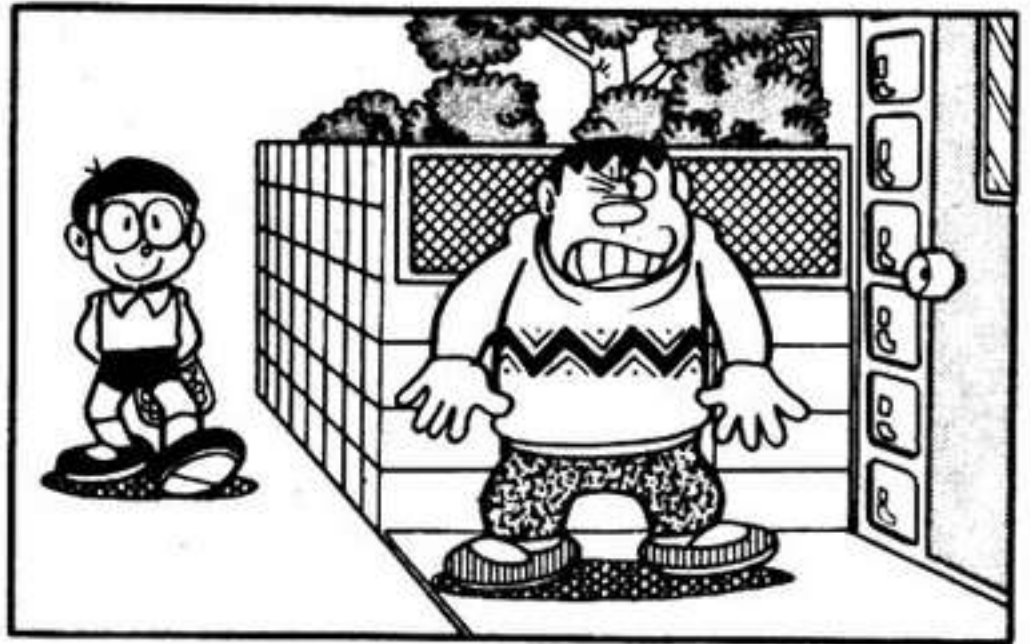
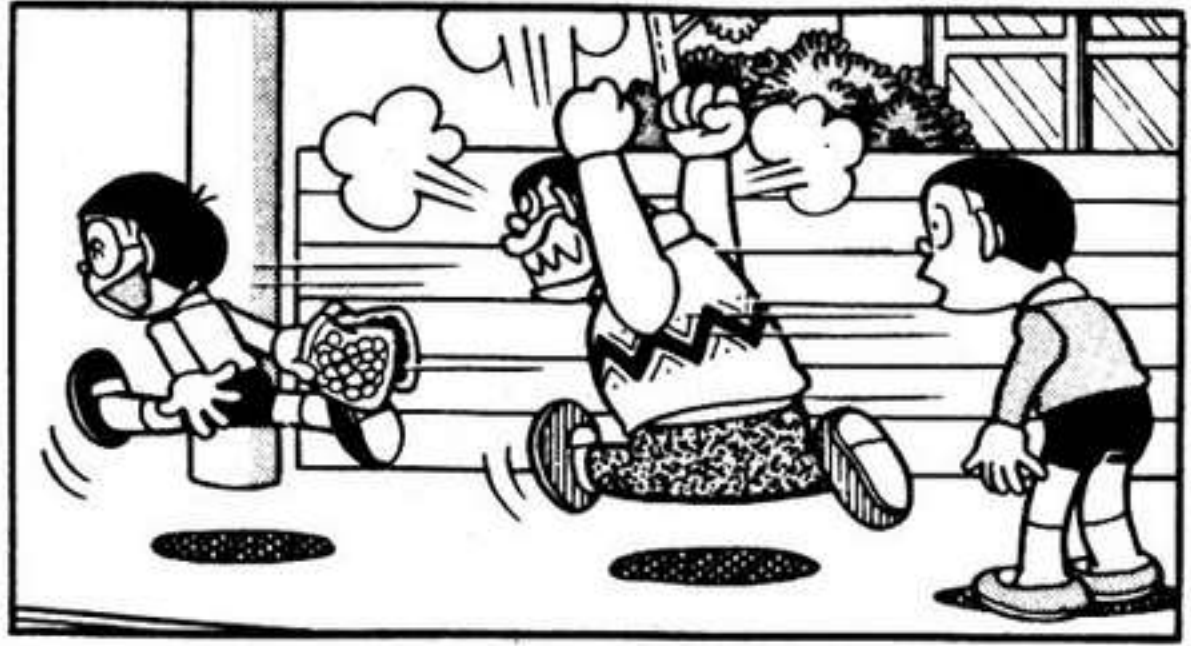

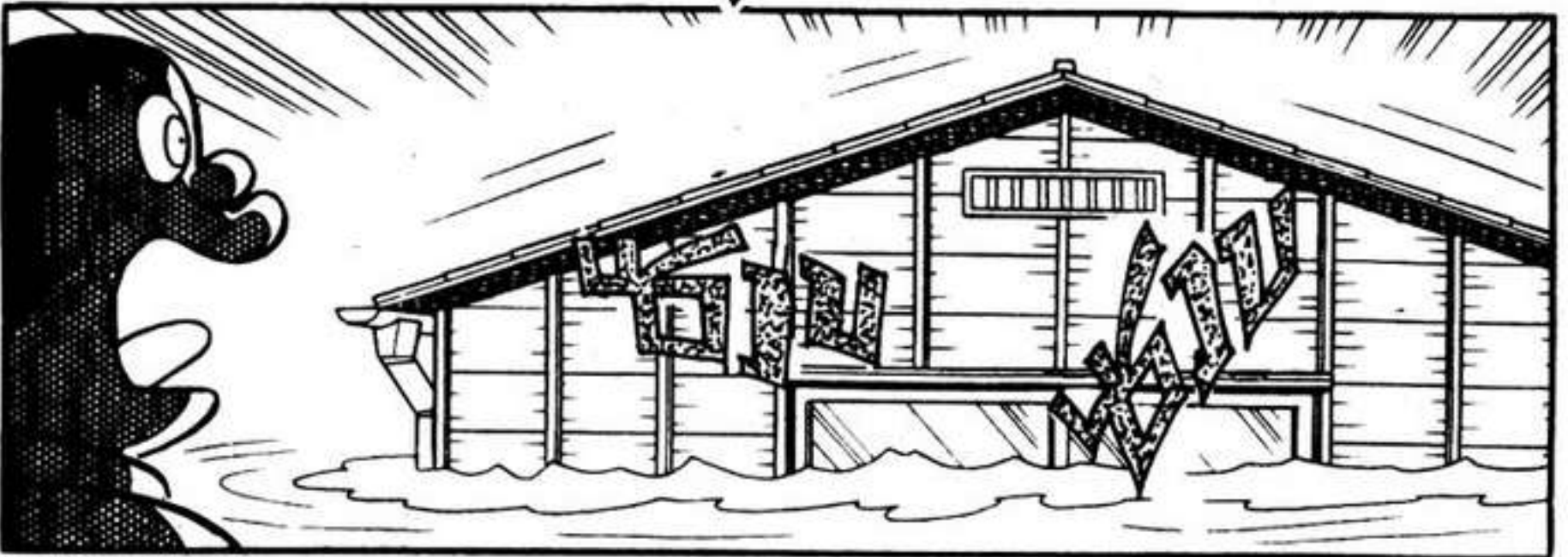





บ้านພັບໄດ້

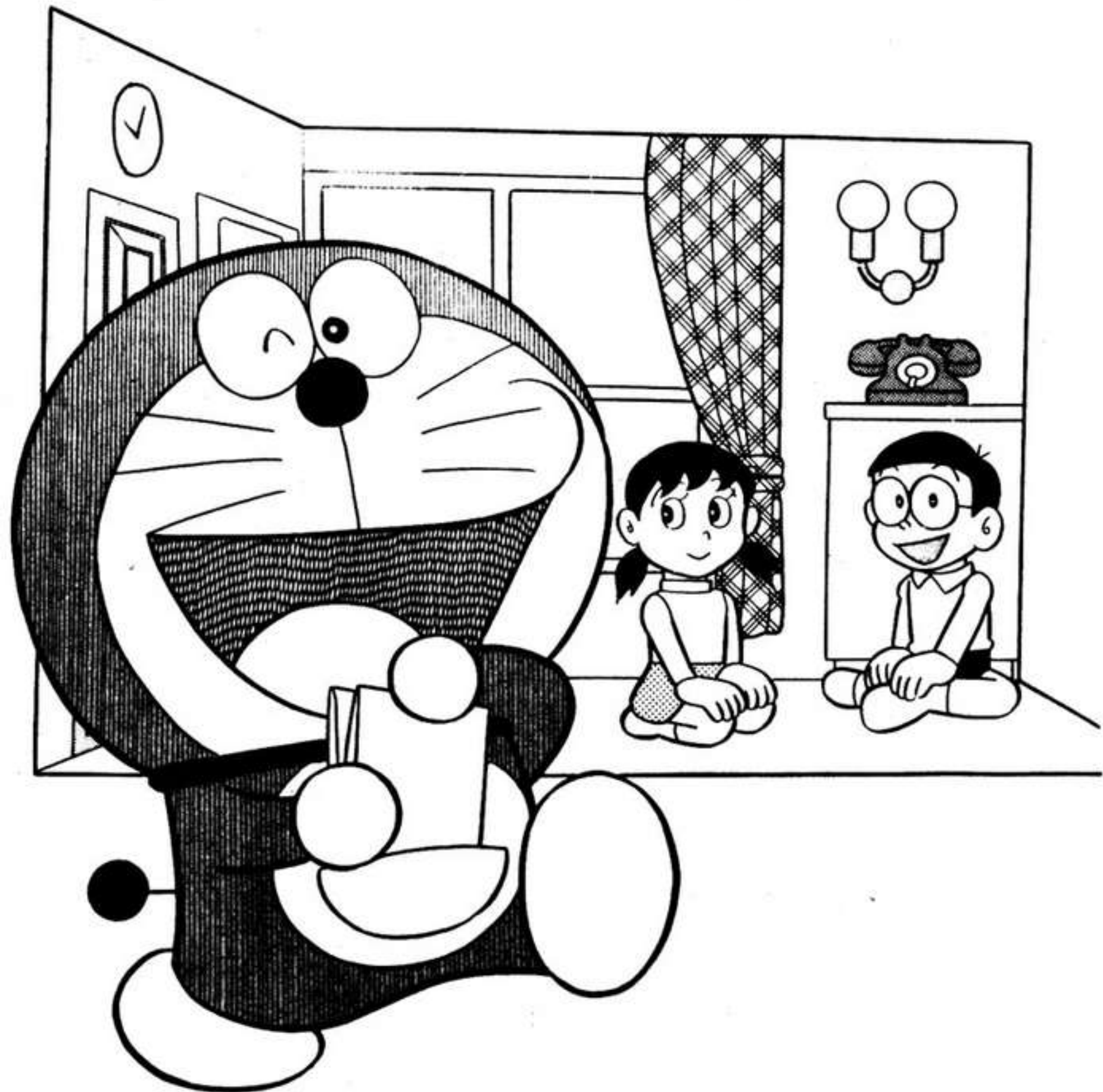

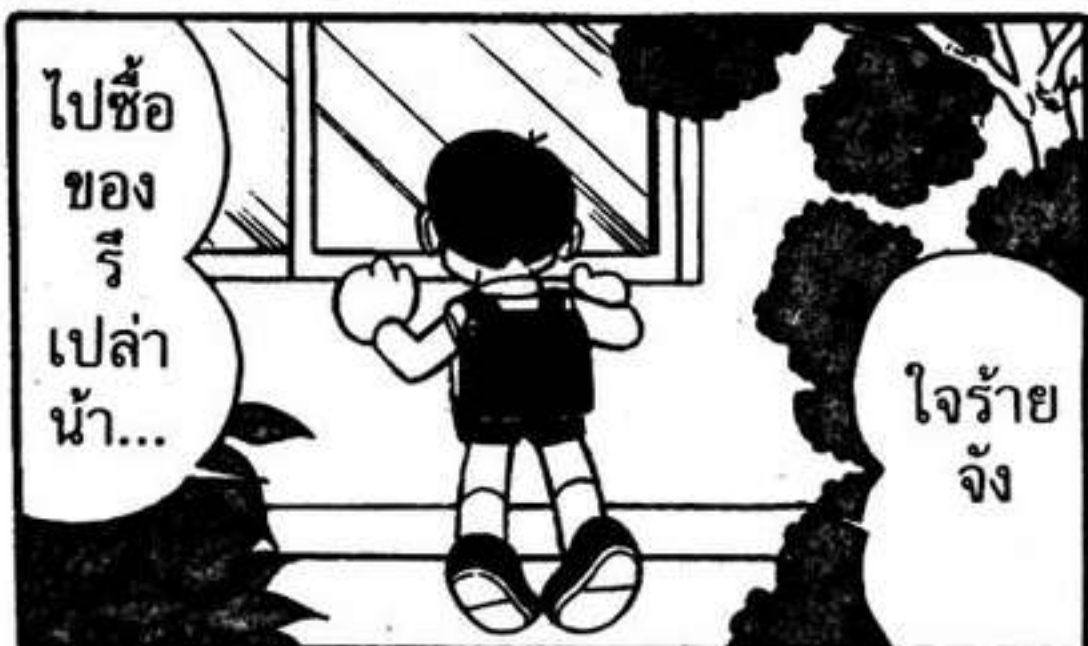

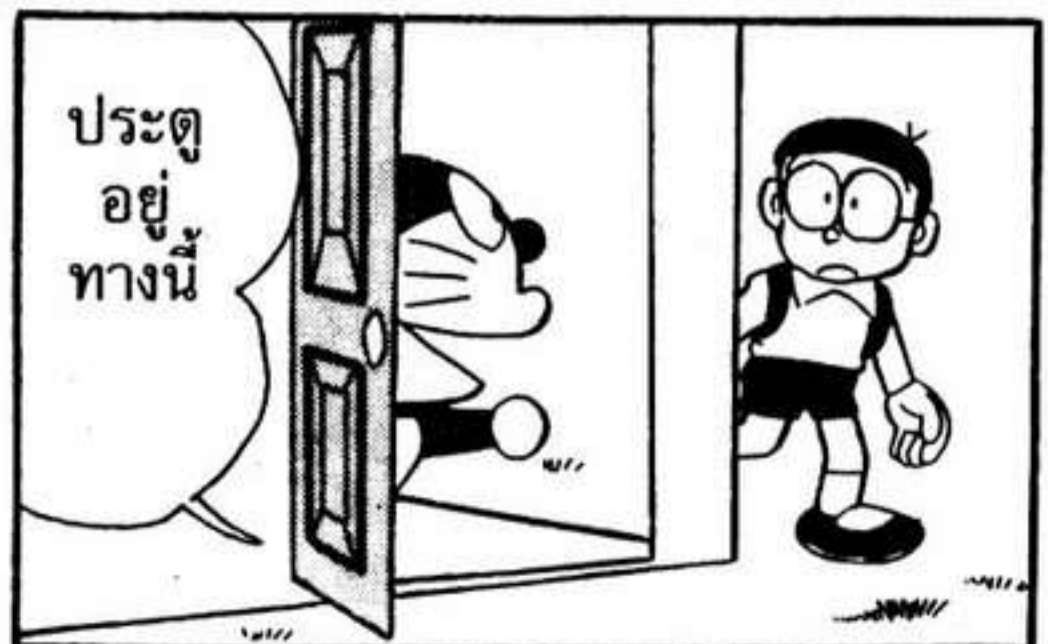
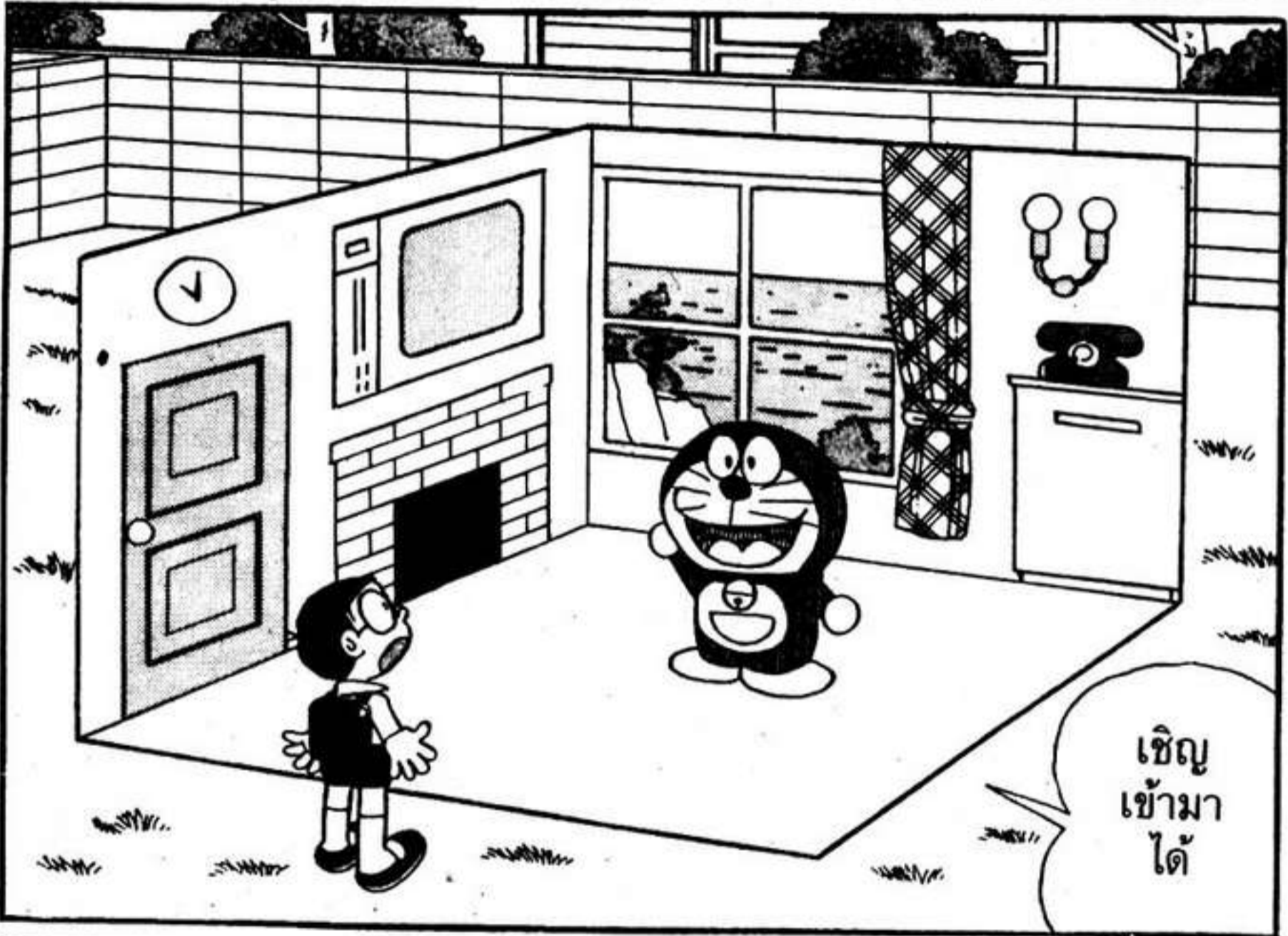



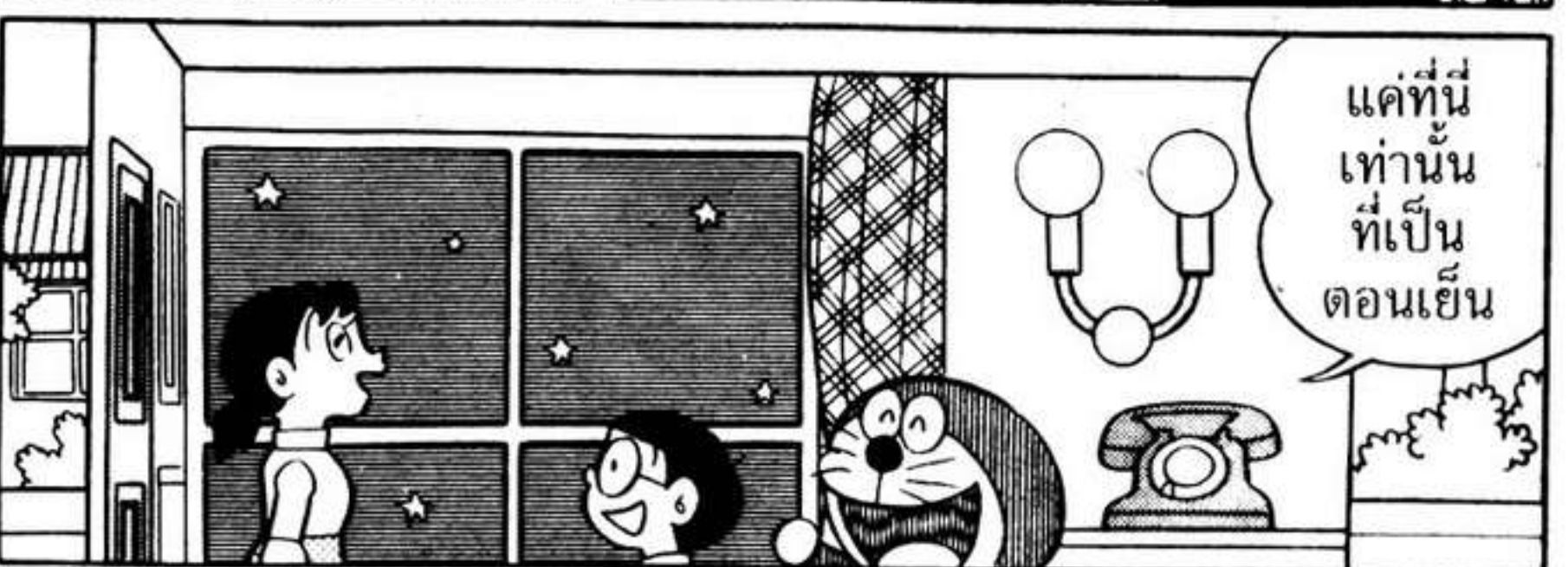
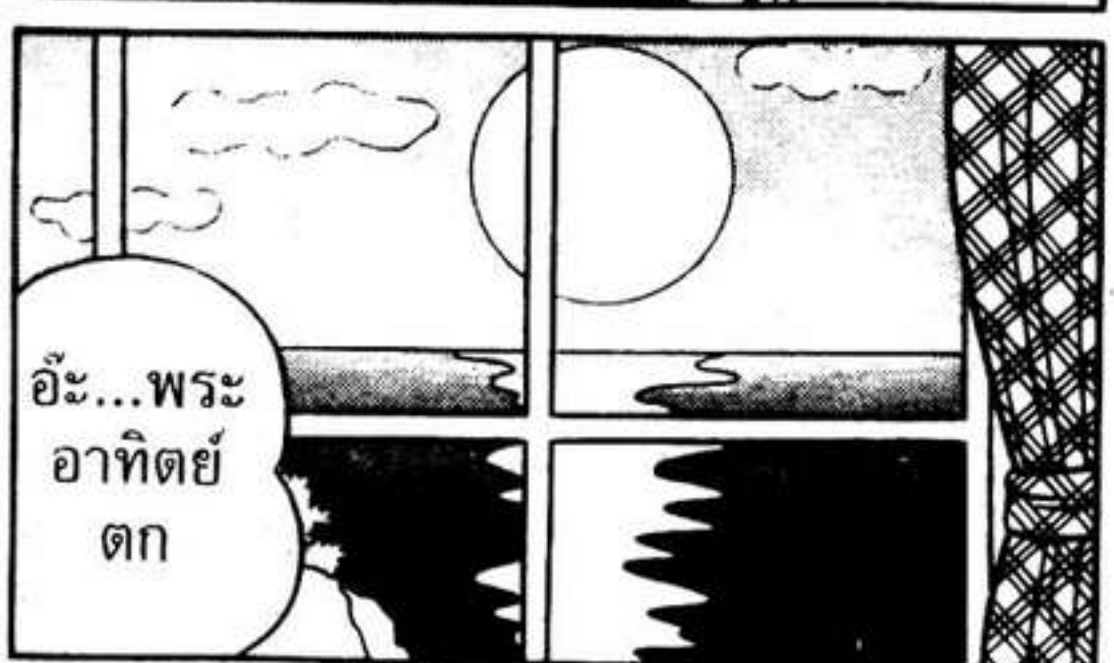





โจโกะนักเขียนการ์ตูน

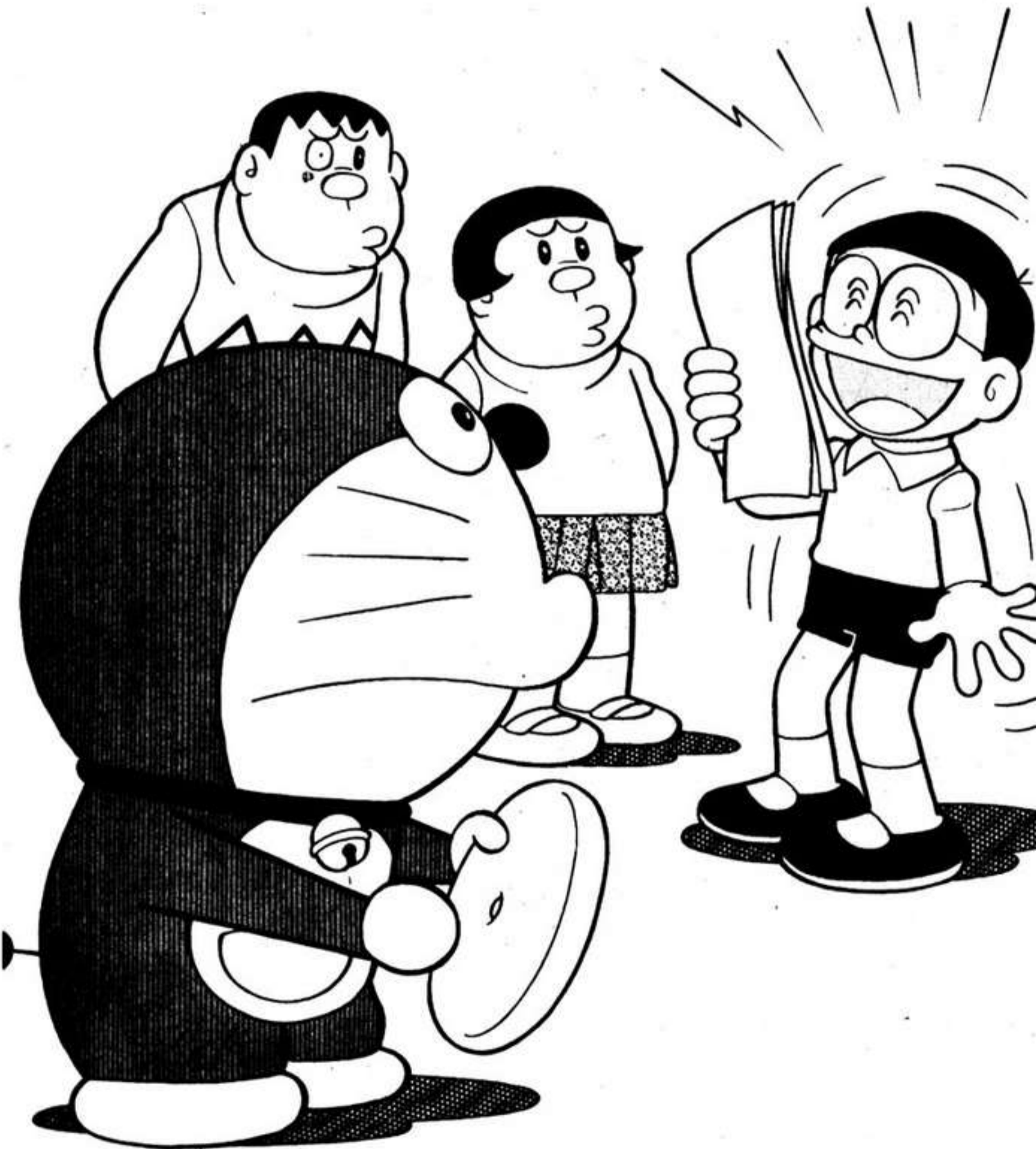







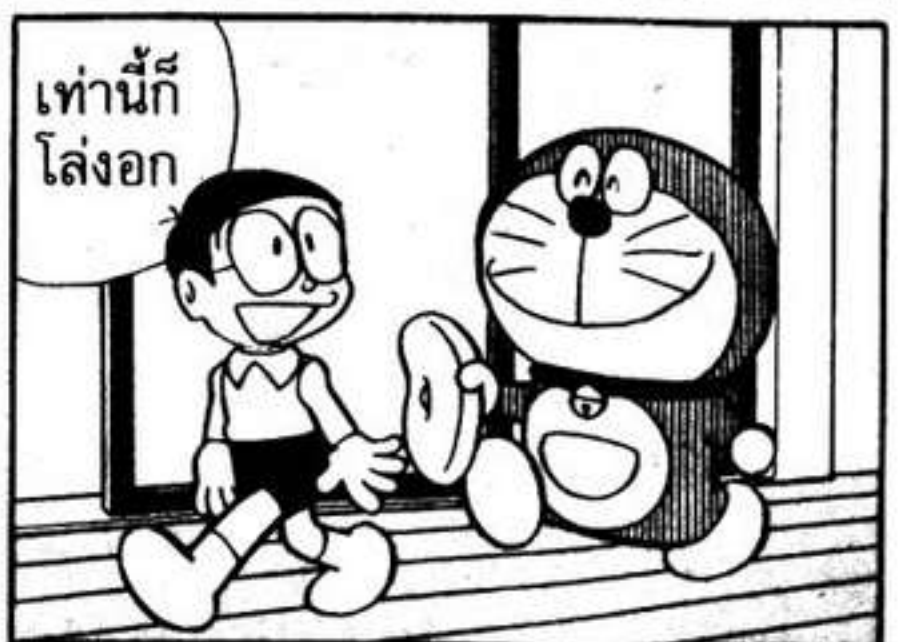



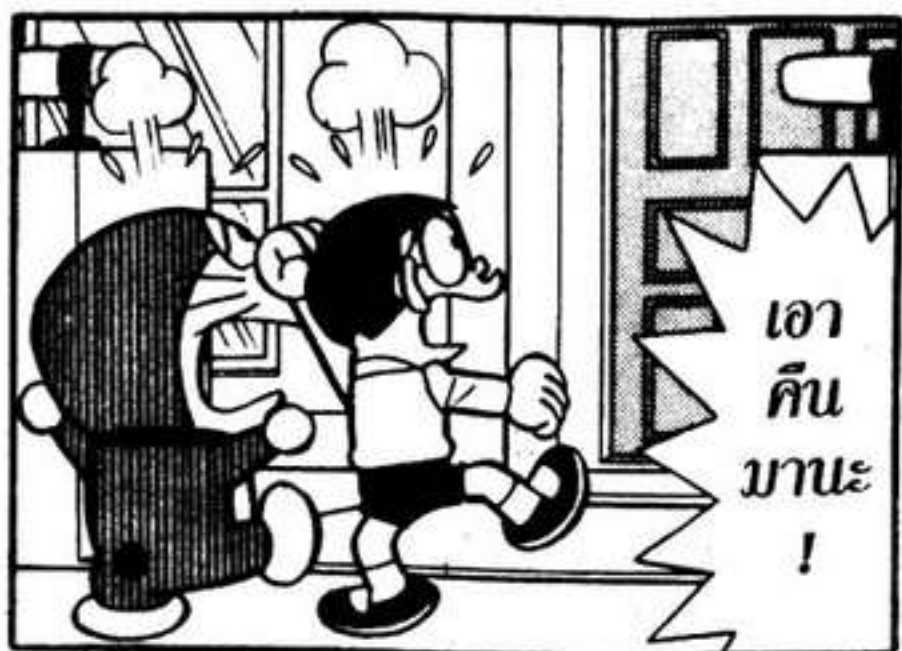



คนดังด้วยแสงโถดำน

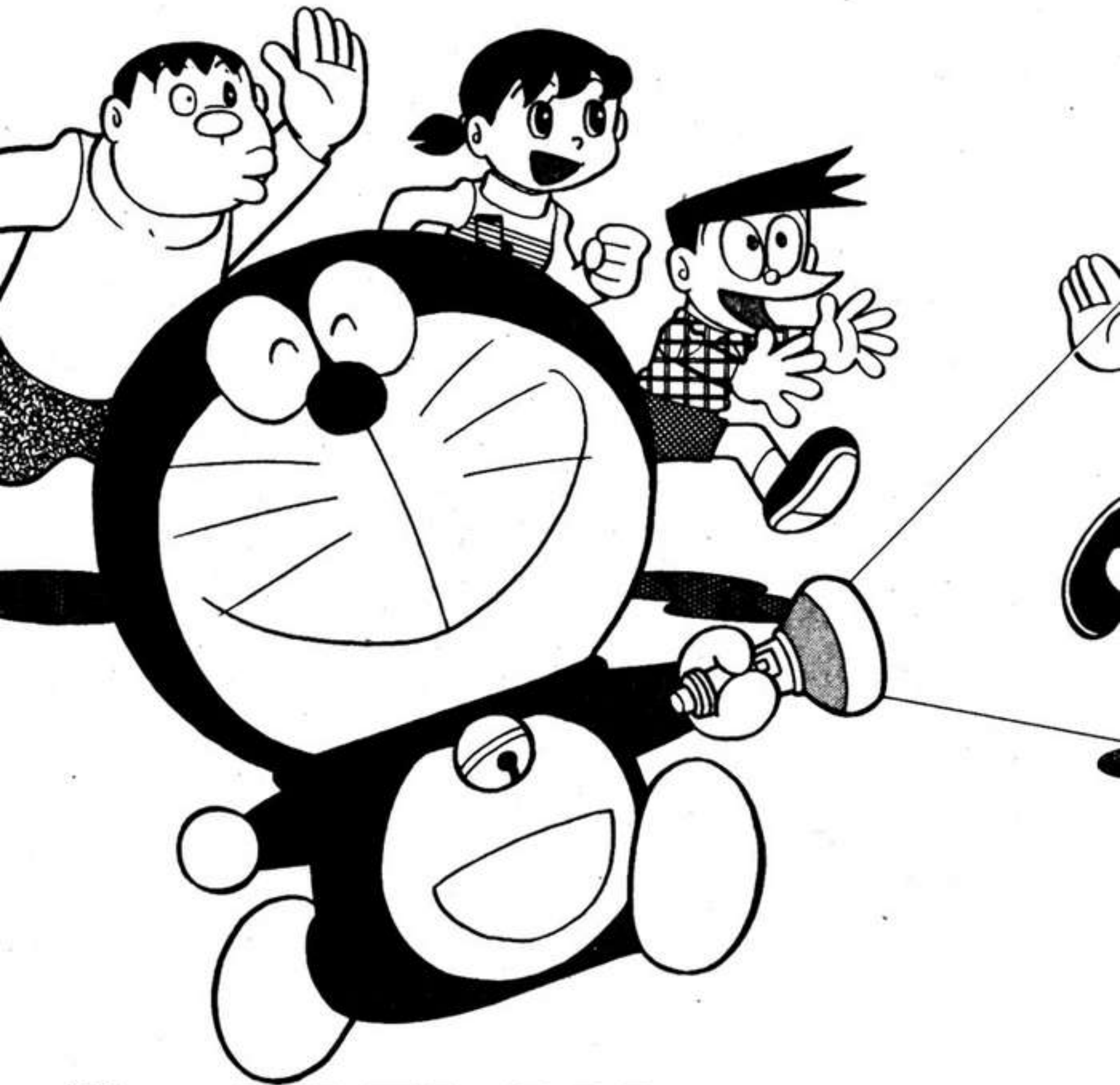



วิธีพันด้าย
แบบใหม่
ฉันคิดขึ้น
เองแหละ

ยัง
ทำ
ยัง...



เห็น
มัย...

ว่า
ไม่มีใคร
มองเลย
.....



อึ้ง? เด็ก
คนนั้น...



ออกทีวี
ตอน
นั้นนี่

ใช้แล้ว
“แชมป์
เปียน
ของ
เมือง”

ร้องเพลง
“ดินยัน
เช้า”
ชนะเลิศ
นะ



กะอีแค่ร้องเพลงเก่ง
นิดเดียวเอง ฉันว่า
พันด้ายยากกว่าชะอีก









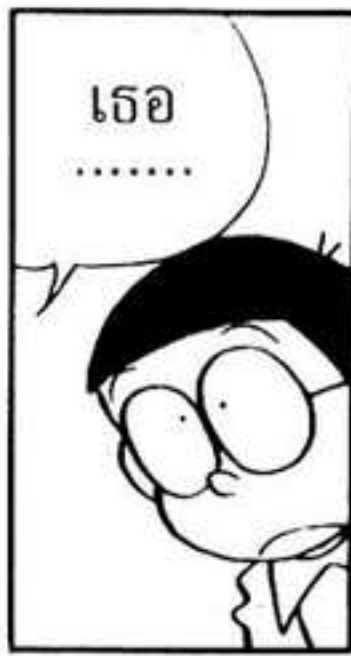
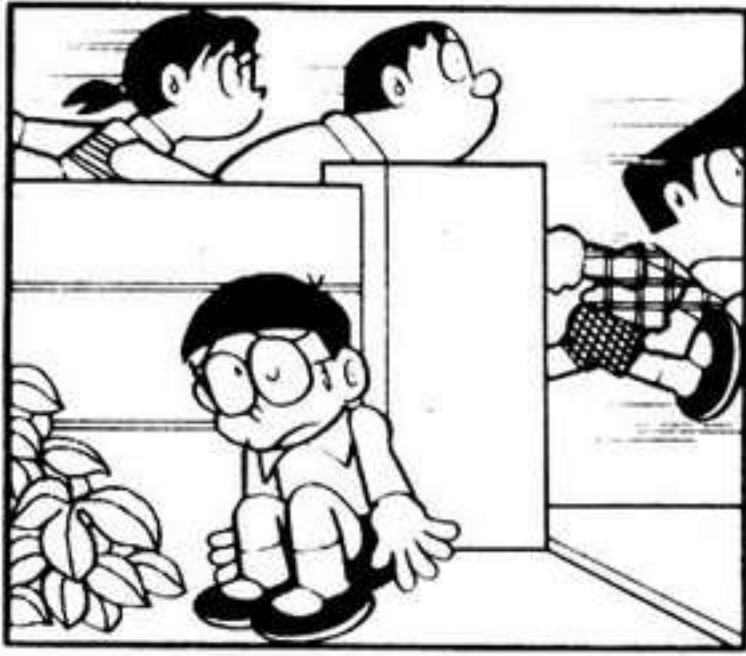

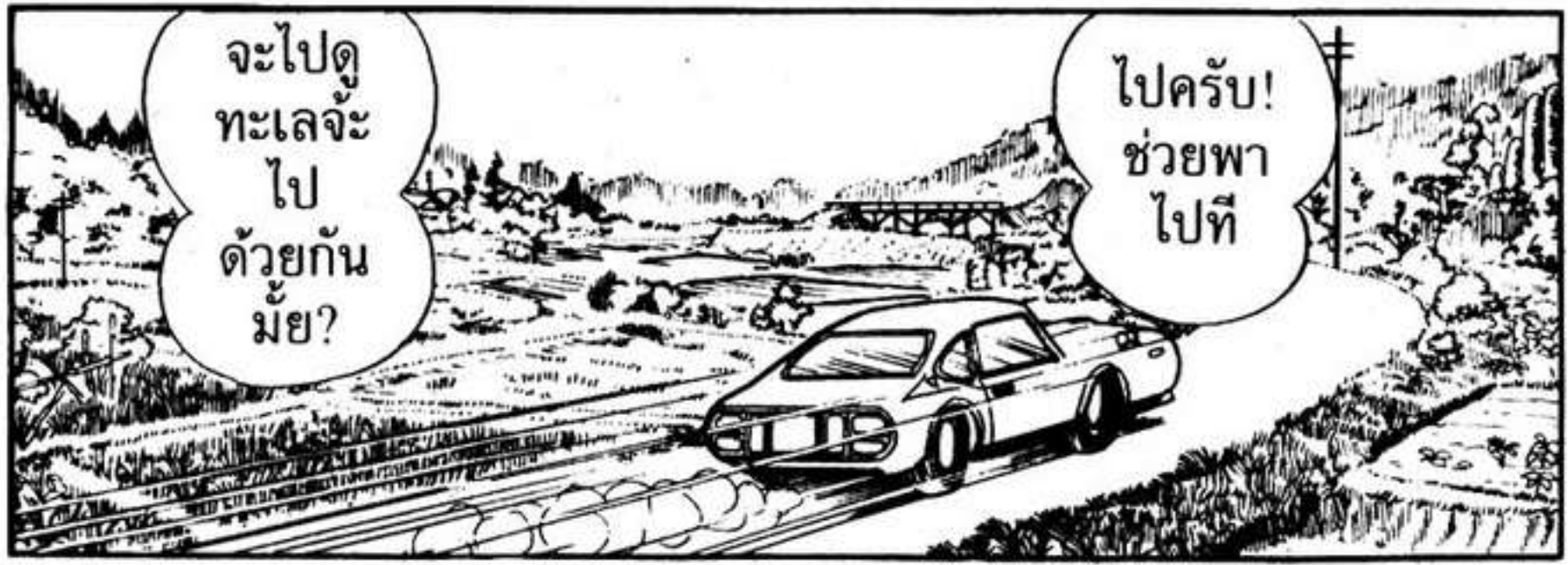





ทะ ทำ
อะไรนะ
!?

เดี๋ยว
ก็รู้



นายเนี่ย
รู้สึกว่าจะ
เป็น

ผู้
รายงาน
ข่าวที่
ออกทีวี



ใช้แล้ว
คนนั้น
แน่!

ตัว
จริง!



ตอนนี้คงต้องหนี
ไปทั่ว คิดว่าไปที่
บ้านคุณซิมิระ
ไม่ได้แล้วอะ

ทำหนังกาการ์ตูนเนี่ยหยา ๆ

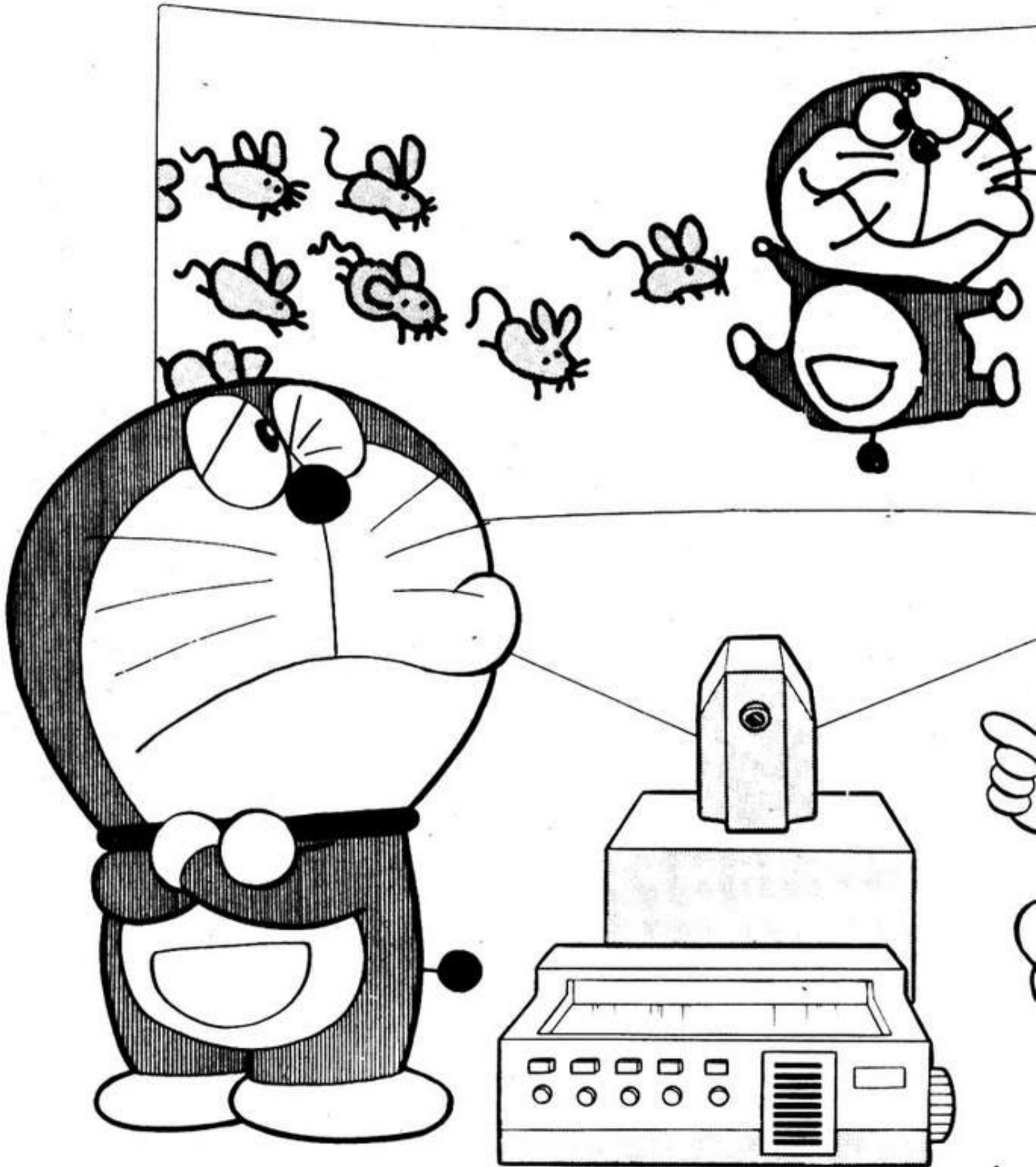



โห...แต่ว่า
จะทำอะไร
ที่นี่?

สตูดิโอที่
ดัดแปลง
มาจากห้อง
เก็บของนะ



ถ้า
ได้ยิน
แล้ว
อย่า
ตกใจ
นะ

ผลิต
หนัง
การ์ตูน
ไว้!!



หนัง
การ์ตูน!?

ที่เคลื่อนไหวได้
จริงๆ นะเธอ



มีหนังการ์ตูนที่
ไม่เคลื่อนไหว
ด้วยหรือ

อีกไม่นานก็จะขาย
ให้ทีวีและโรงหนัง

จริงเหรอ





ดังนั้นจึงต้องเขียน
ภาพที่แตกต่างกัน
ทีละนิดหลายๆ ใบ



ยุ่งยาก
ขนาดนั้น
เชียวเหรอ

จริง
หรือ



ถ้านายสงสัยมาลองแอบ
ดูบ้านซีเนะโอะ
กัน



ซีเนะโอะ
สตูดิโอ

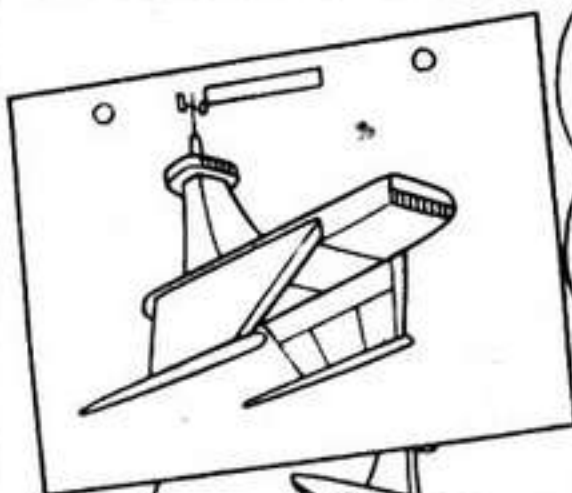

ภาพ
ที่ต่างกัน
เล็กน้อย
จะเป็น
แบบนี้



ถ้าซ้อน
กัน
เร็วๆ

นี่ไง เห็นได้ว่า
เคลื่อนไหว

จริง
ด้วย



จะ
เขียน
!

ก็ไป
ฉันทัก
จะเขียน



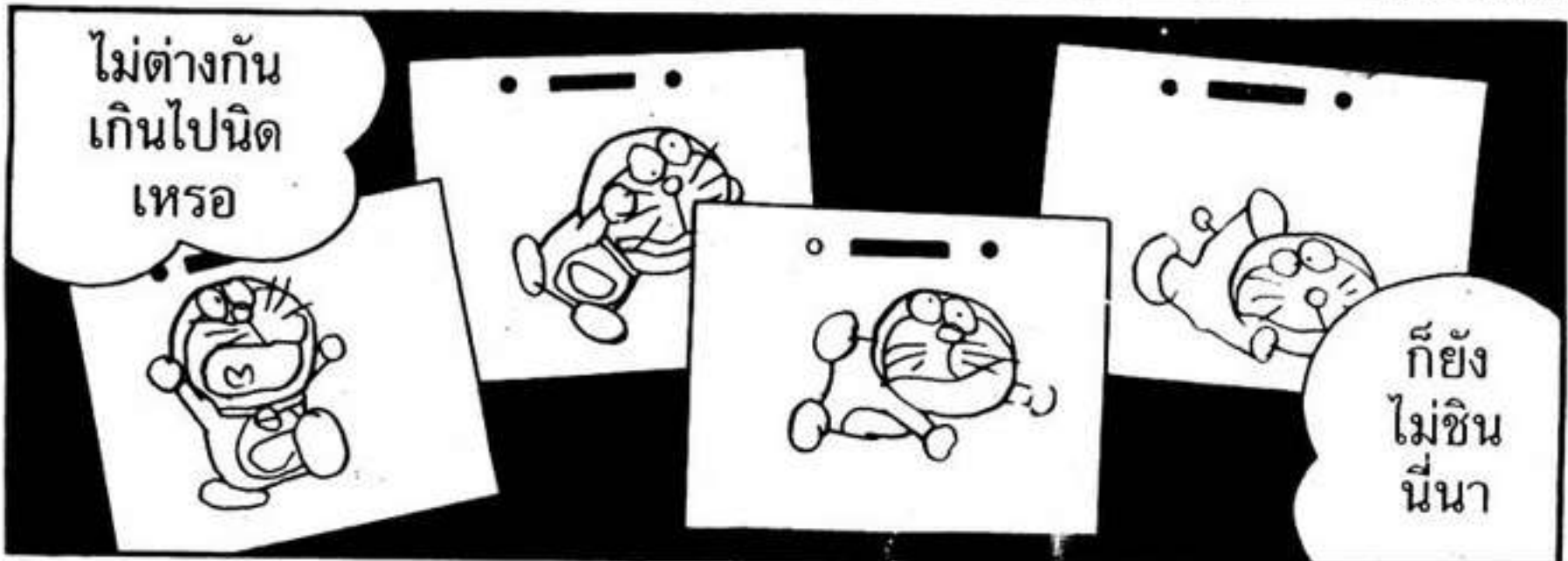

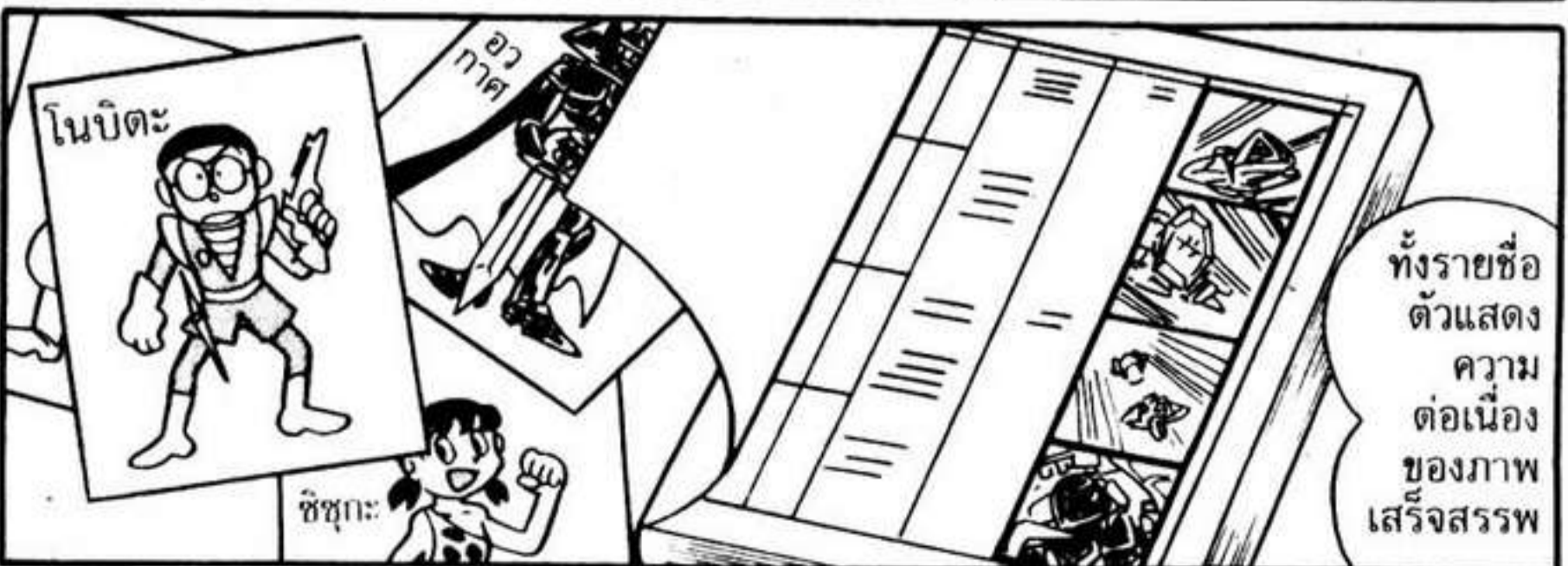



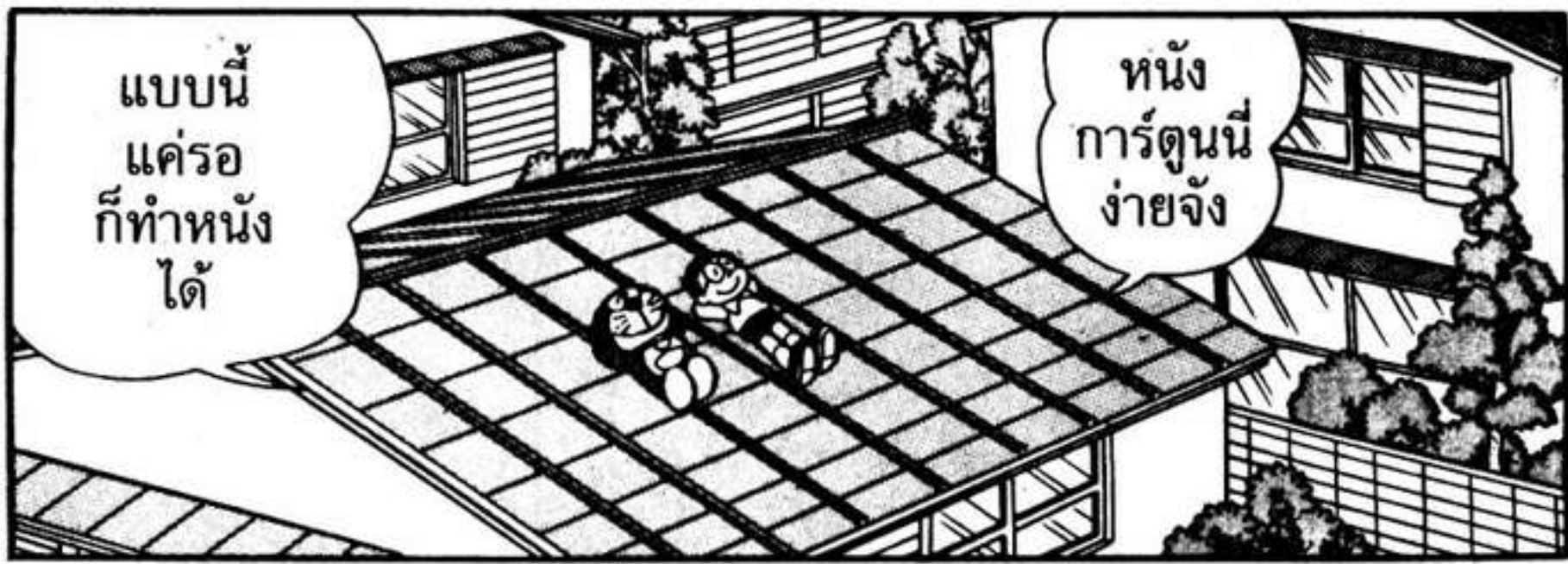



โห

เจ็บใจ
แต่ก็
สนุก

ฉันลำบาก
กับมันมาก
พอควร
เหมือนกัน



จน

เทียบกับหนัง
ของนายแล้ว
เป็นยังไง?



เดี๋ยว
ก่อน!

ฉาย
รายชื่อ
ผู้จัดทำ
แล้ว



อำนาจการสร้าง.... เครื่องผลิตการ์ตูน
บทภาพยนตร์.... เครื่องผลิตการ์ตูน
ตัวแสดง.... เครื่องผลิตการ์ตูน
ศิลป์.... เครื่องผลิตการ์ตูน
ภาพต้นฉบับ... เครื่องผลิตการ์ตูน
ภาพเคลื่อนไหว.... เครื่องผลิตการ์ตูน
ตากล้อง.... เครื่องผลิตการ์ตูน
ผู้กดปุ่ม.... โตราเอมอน

โนบิตะ
แล้ว
นายทำ
อะไร
นะ!?

กล่องหกด่าน

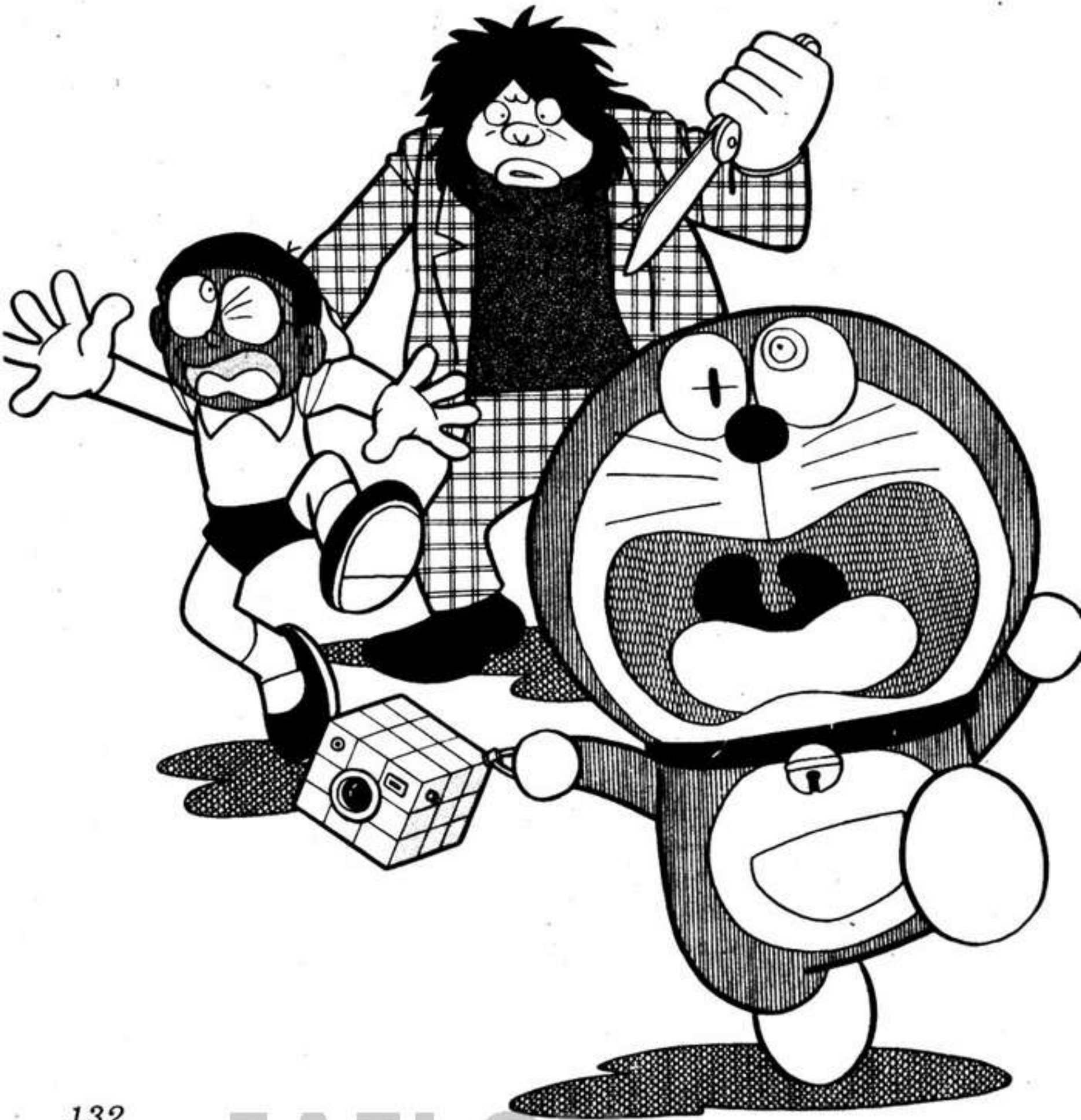



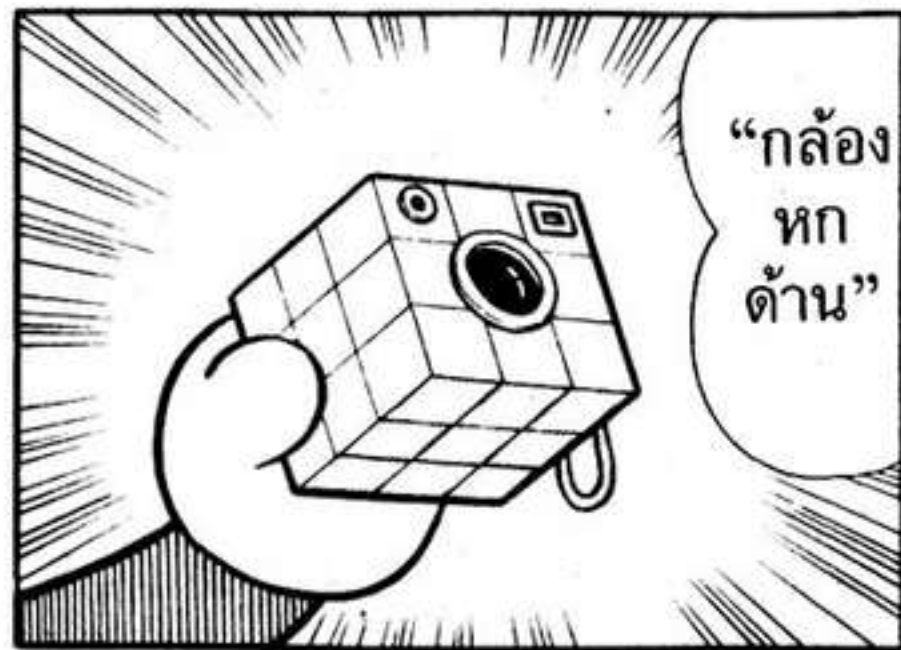
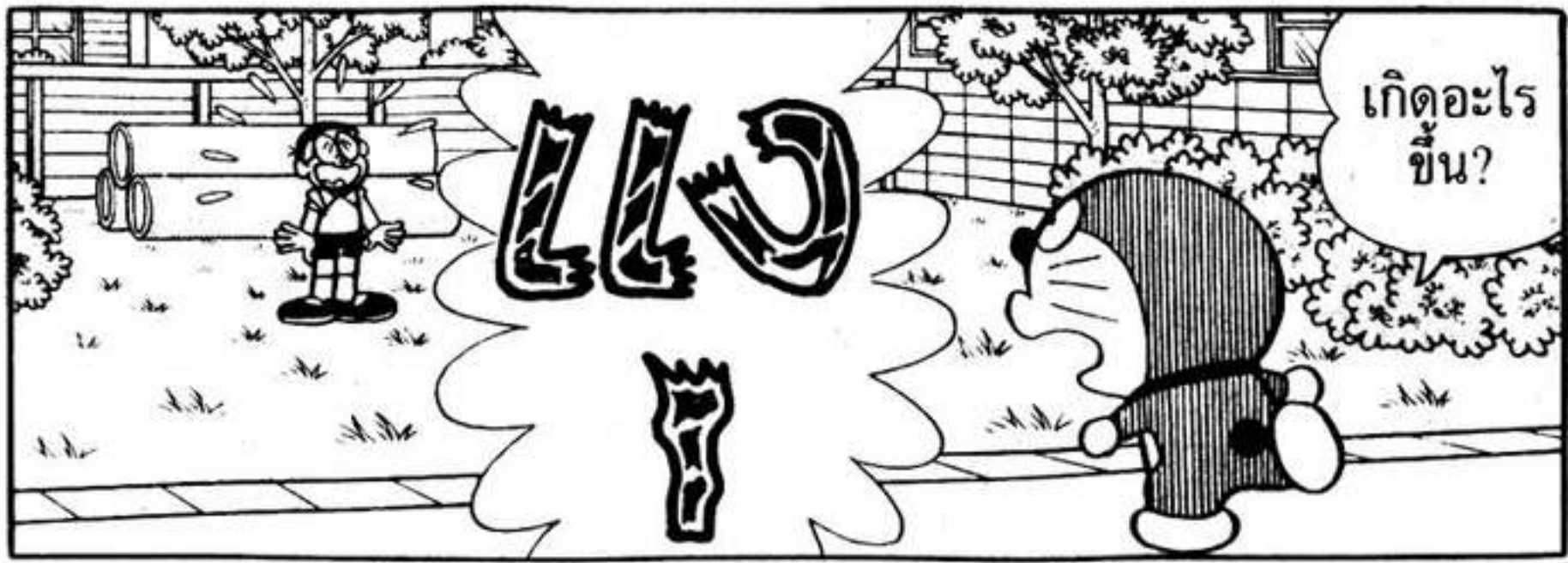

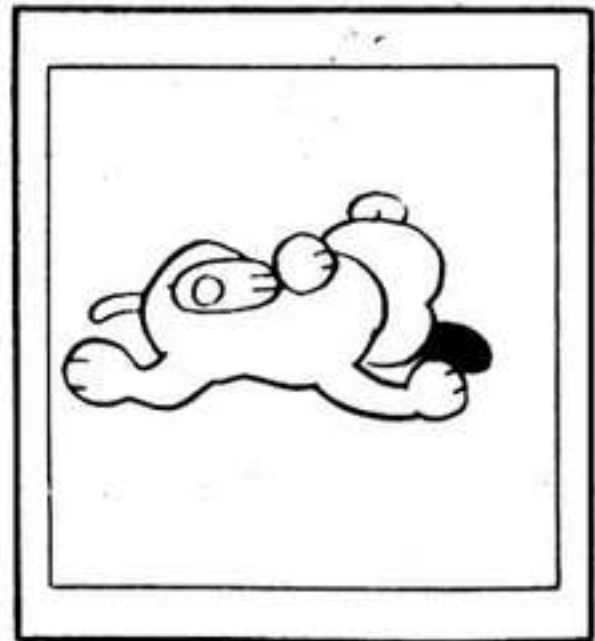
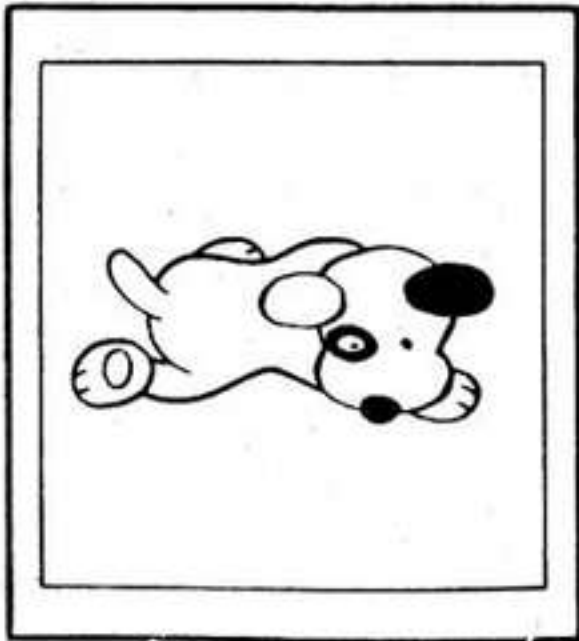
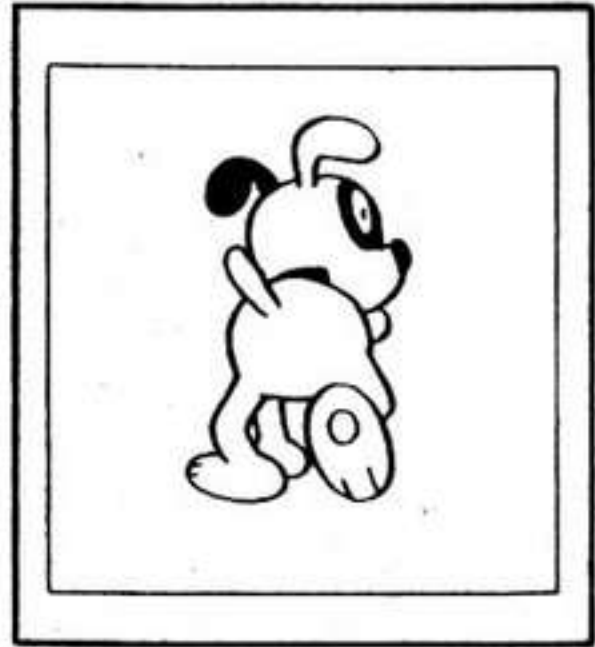
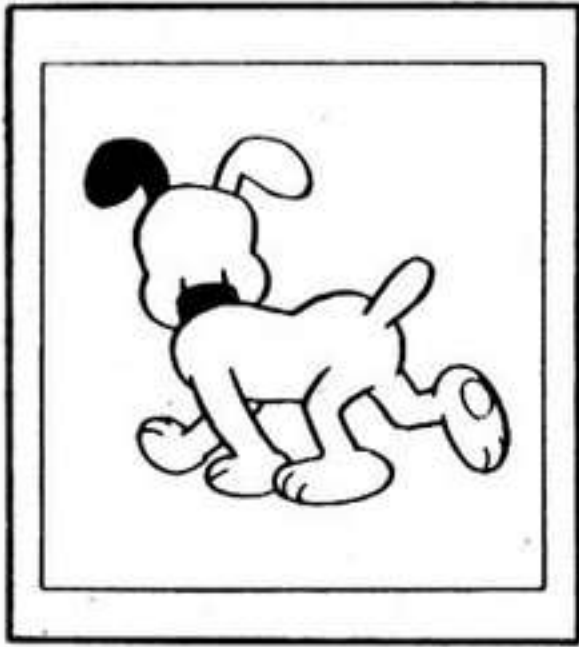

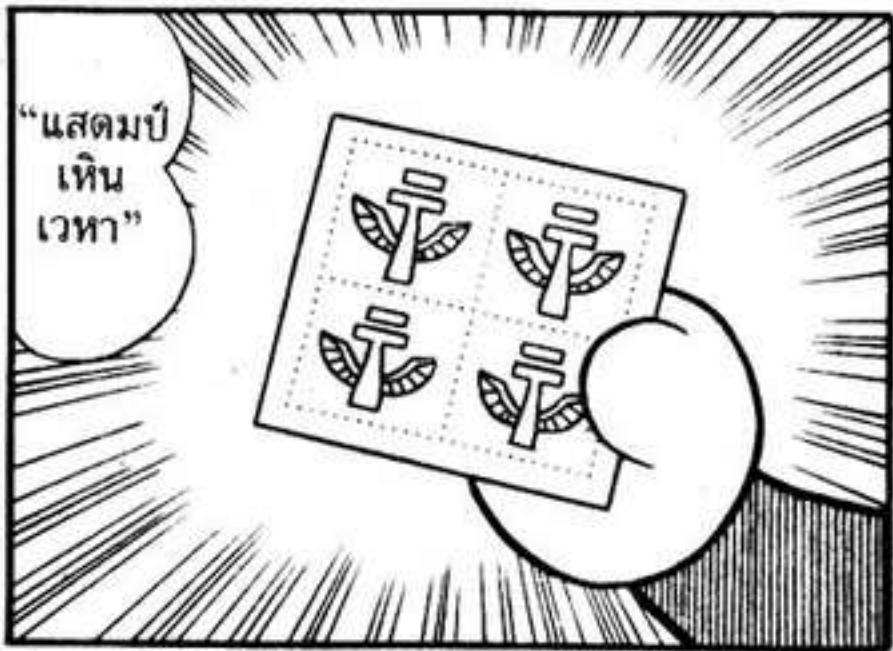
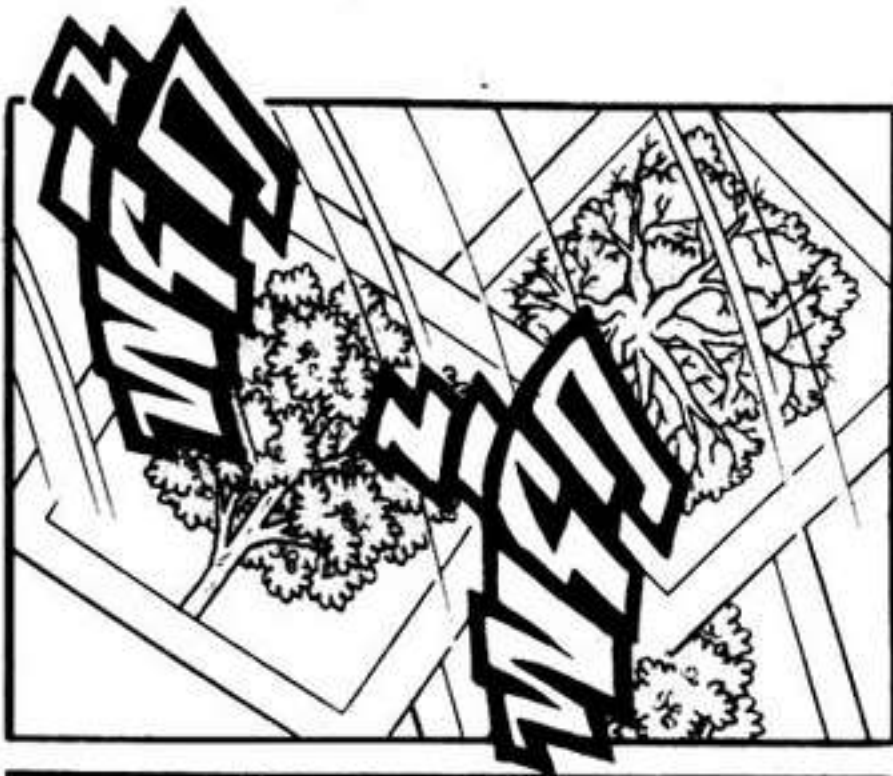

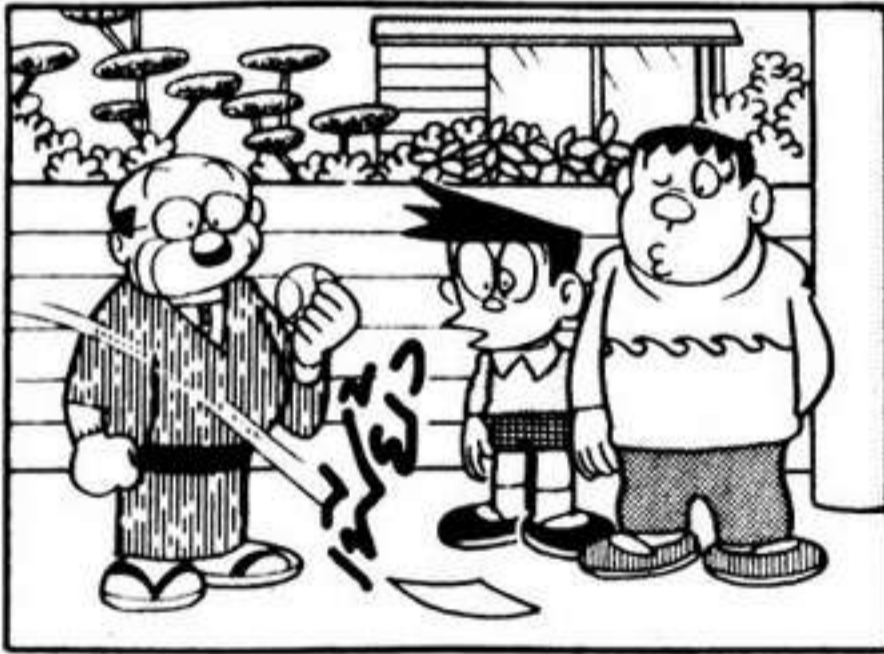
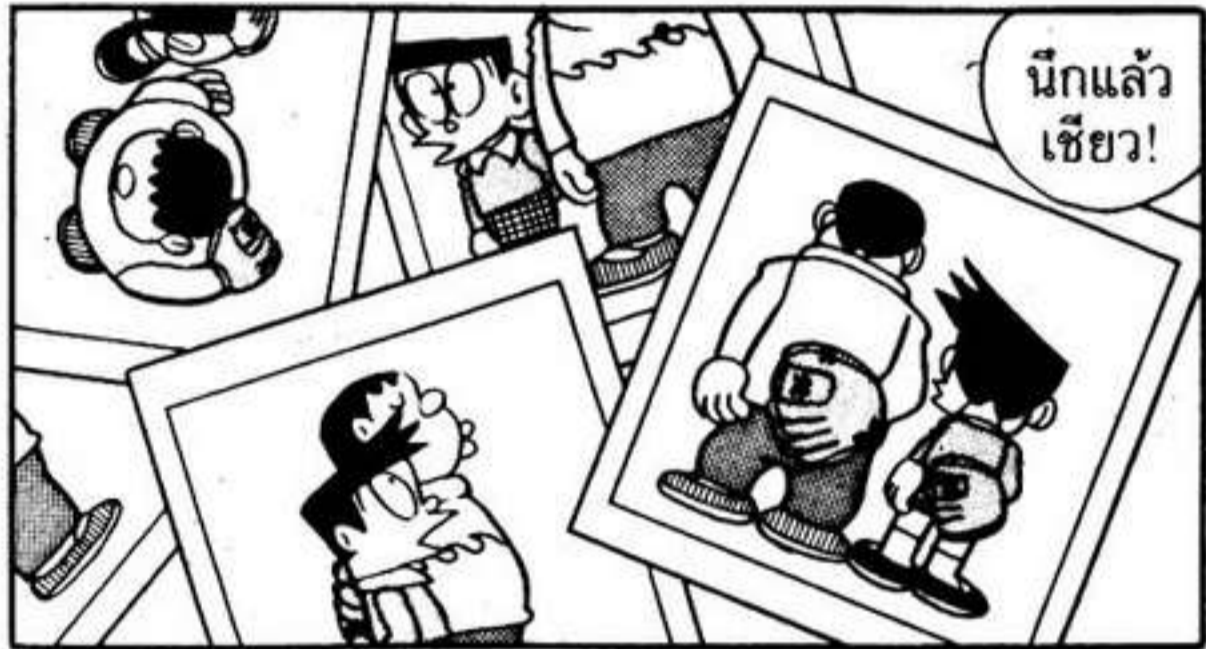

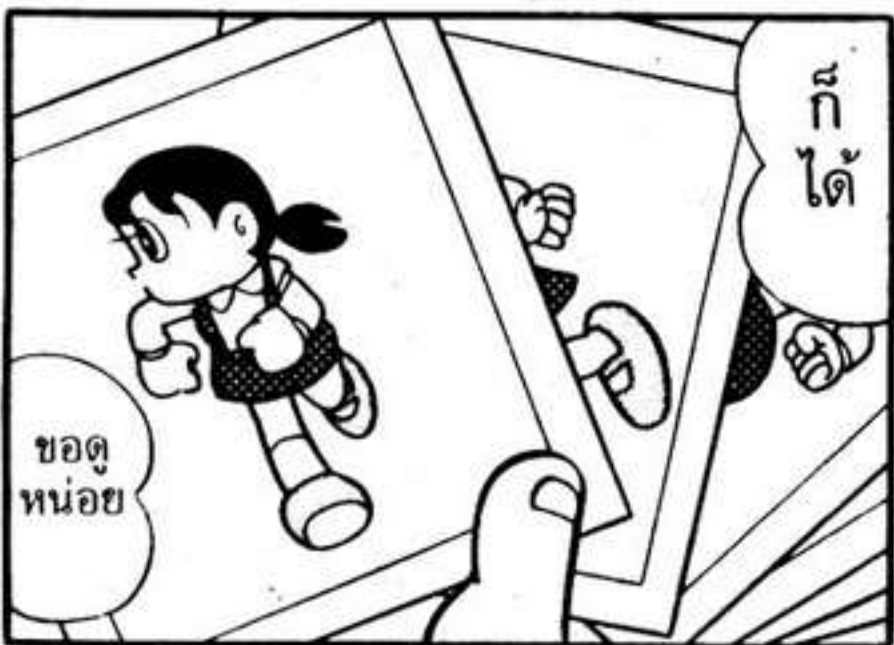
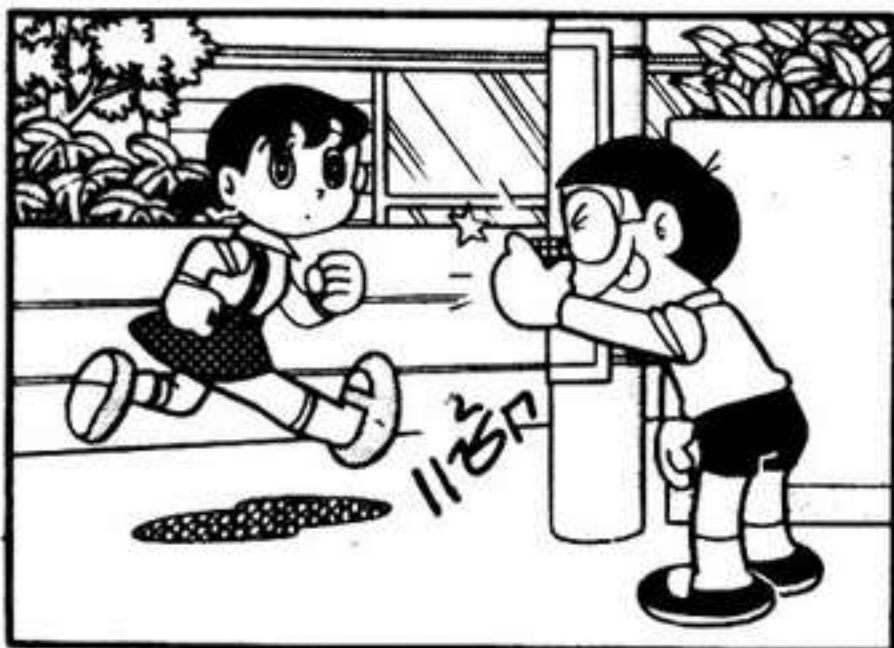
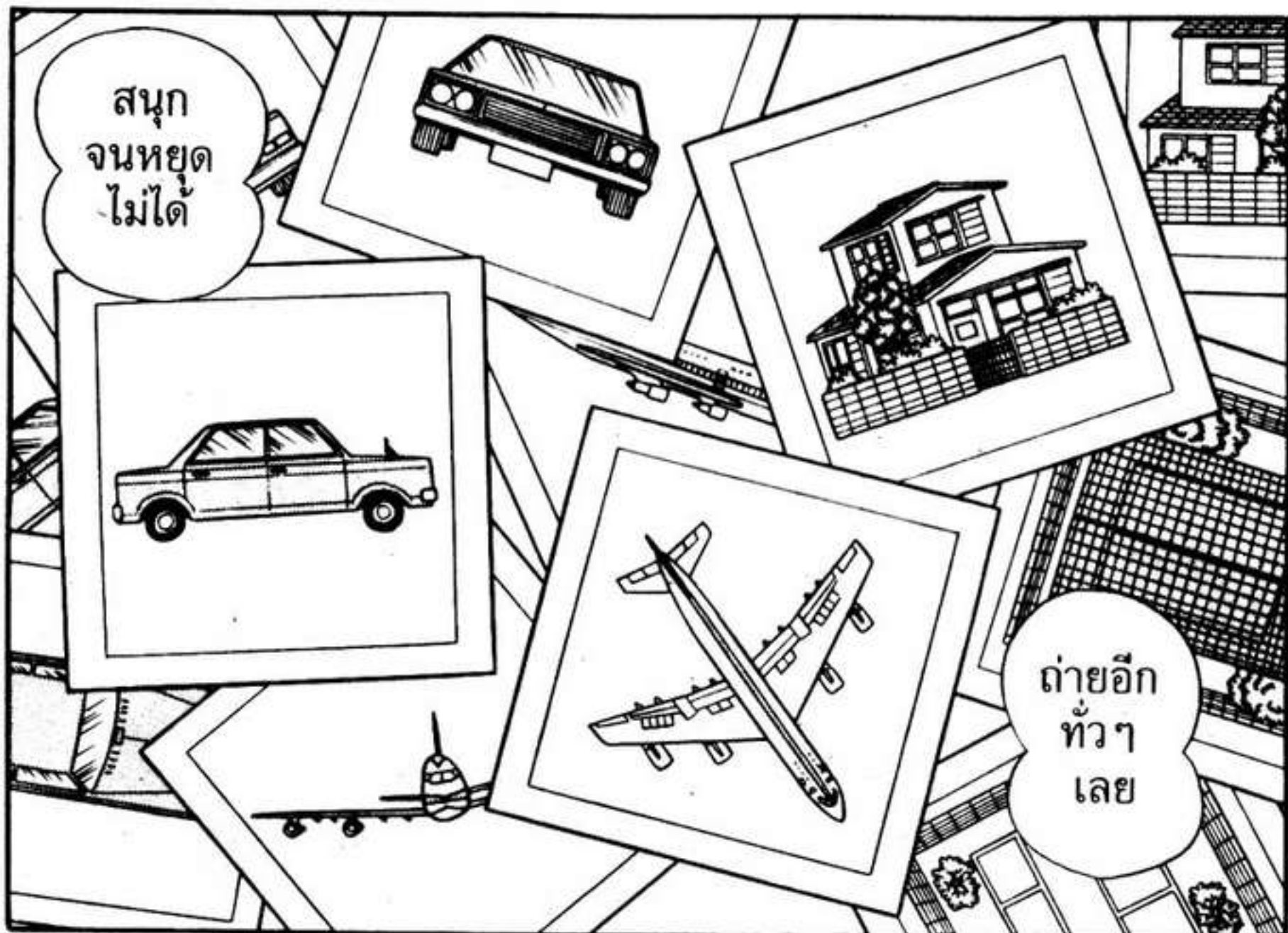



ตำรวจไปยิงที่เกิดเหตุทันทีหลังจากทราบข่าว แต่ปรากฏว่าคนร้ายได้หนีไปเรียบร้อยแล้ว





เป็นความผิดที่
ใช้กล้องยั้งงี้โดย
ไม่ได้ยั้งคิด

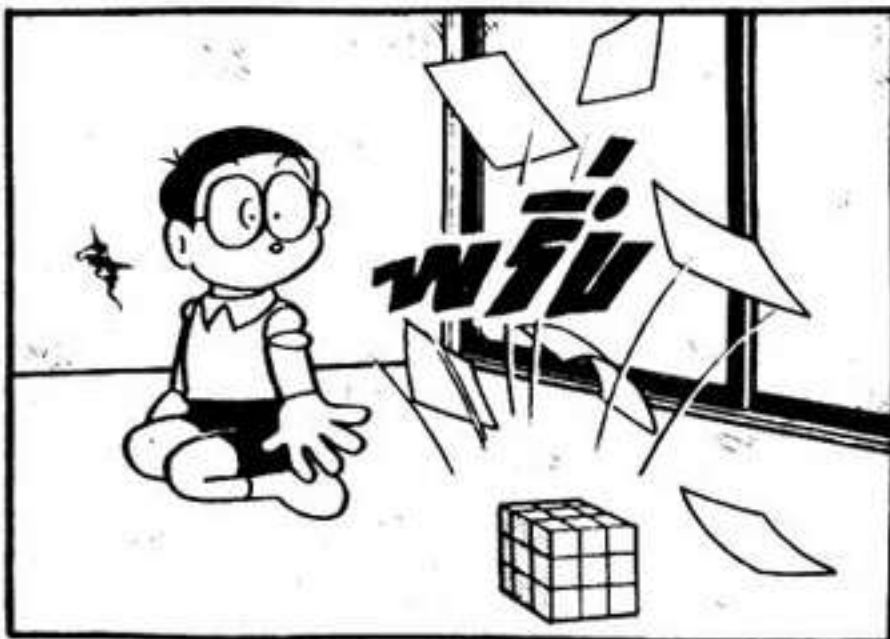
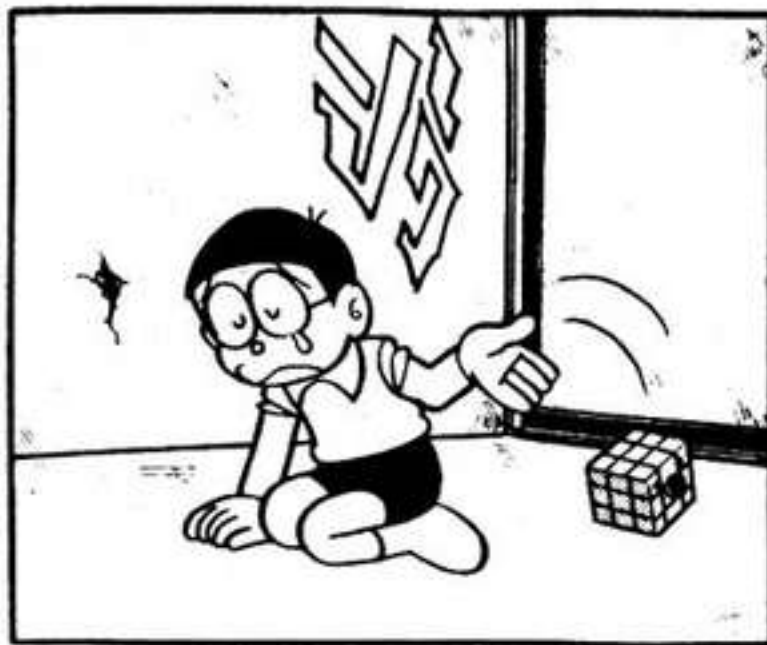
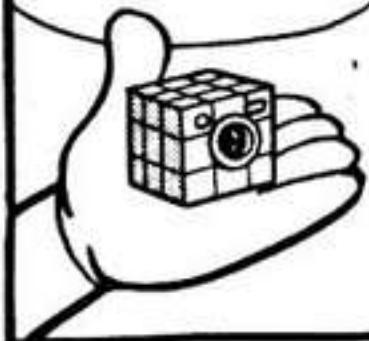

ชัตเตอร์
กดไปเอง
รีง

ถ่ายอะไร
ไม่น่า
สนใจเลย



ประตูที่
เห็นจาก
ทางเดิน
.....

อ๊ะ



แทนที่จะ
เป็นป้าย
ชื่อ หน้า
ประตู

นายขโมย
ตัวอ้วน
ห้องเลขที่ 5
คูชีโรโซ, ซินจุกุ
เหนือเขตซินจุกุ
โตเกียว 201

นาม
บัตร
!



รู้ชื่อและ
ที่อยู่เจ้า
วายร้าย
แล้ว

ไปแจ้ง
ตำรวจ
ดีกว่า



ถ้าทำแบบนั้น
ได้ก็หนี
ได้แล้วนะสิ



ดะดะดะ
บะดะดะดะดะดะดะดะ

วิธีเพลินกับเสียงเพลง ของจอห์น





นี่เป็นครั้งที่เท่าไรที่เลิกบุหรืไม่สำเร็จคะ

วิชา สุขบุหรื



พูดแบบนี้ก็น่าอายอยู่หรอกแต่ว่า

พอไม่ได้สูบลักพักนึงมันหงุดหงิดๆ



โรคพิษนิโคตินเรื้อรังโดยสมบูรณ์มั่งคะ



โรคพิษนิโคตินเรื้อรังเนี่ยอะไร?

นิโคตินเป็นสารประกอบอยู่ในบุหรี่
ถ้าเข้าไปในร่างกายแล้วจะทำให้ติด
และเลิกสูบบุหรี่ไม่ได้.....



หัวจะมีนั่ง
หงุดหงิด ไม่มี
สมาธิในการ
ทำงาน



น่ากลัว
จังเลย



โรคพิษ
สุรา
เรื้อรัง
ก็มี
นะ

ทั้งกลางวันกลาง
คืนว่ากันว่าถ้า
ไม่มีเหล้าจะอยู่
ไม่ได้...



นายเนี่ยตอนนี้เป็น
โรคพิษนอนกลางวัน
เรื้อรังหรือ....

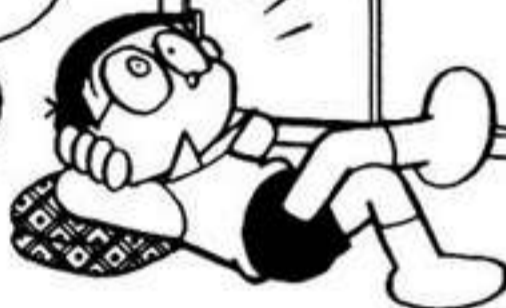

ไม่มียาแก้โรค
ติดนี้เหรอ?



ไม่มีของ
ยั้งน
ด้วยซี



แต่ถ้ายา
ทำให้เป็น
โรคติด
ละมี



“ยา
เลิก
ไม่ได้”

ของเหลวไหล
แบบนี้ใช้
ทำอะไร?



มีประโยชน์
หลายอย่าง
รู้ป่าว



อย่างเช่นให้เด็กที่ไม่ชอบกินหัวแคโรทกิน
หัวแคโรทชนิดหนึ่งพร้อมกับยานี้แล้วก็จะชอบ
หัวแคโรทขึ้นมากจนขนาดถ้าไม่ได้กินยัง
หงุดหงิดเลย หรือทำให้เด็กไม่ชอบเรียน
เปลี่ยนมาชอบ
เรียนหนังสือ

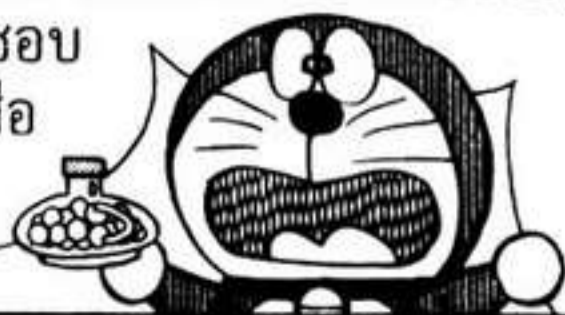



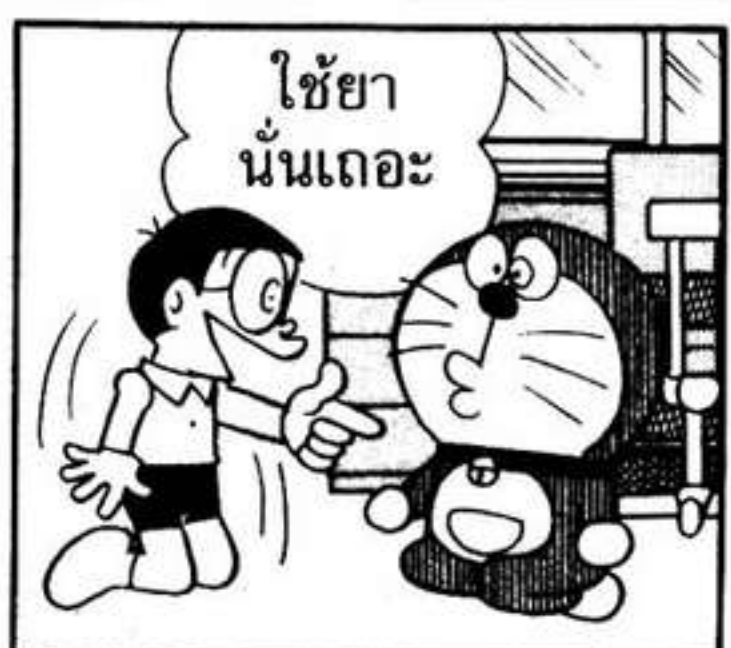





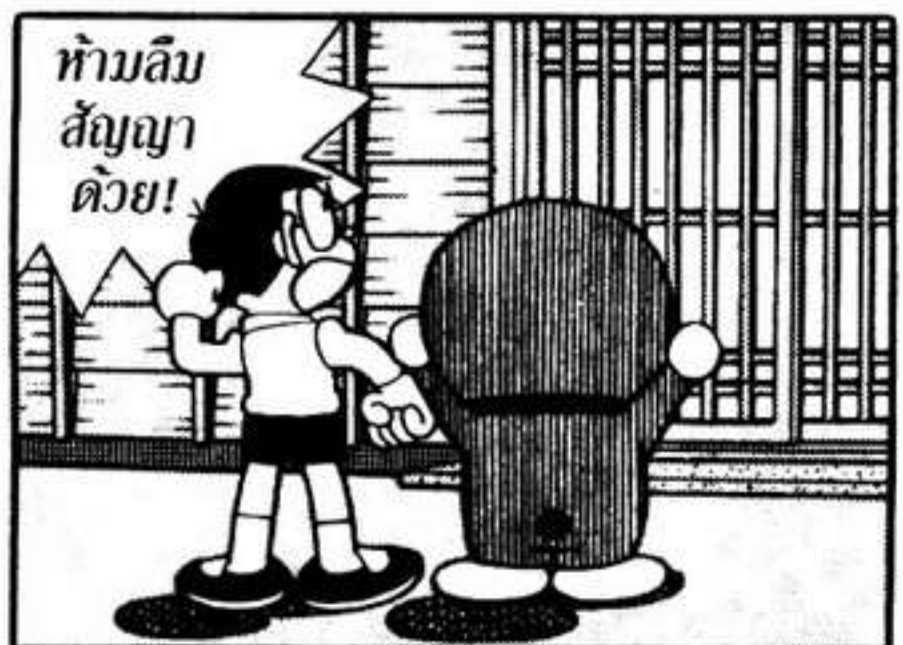
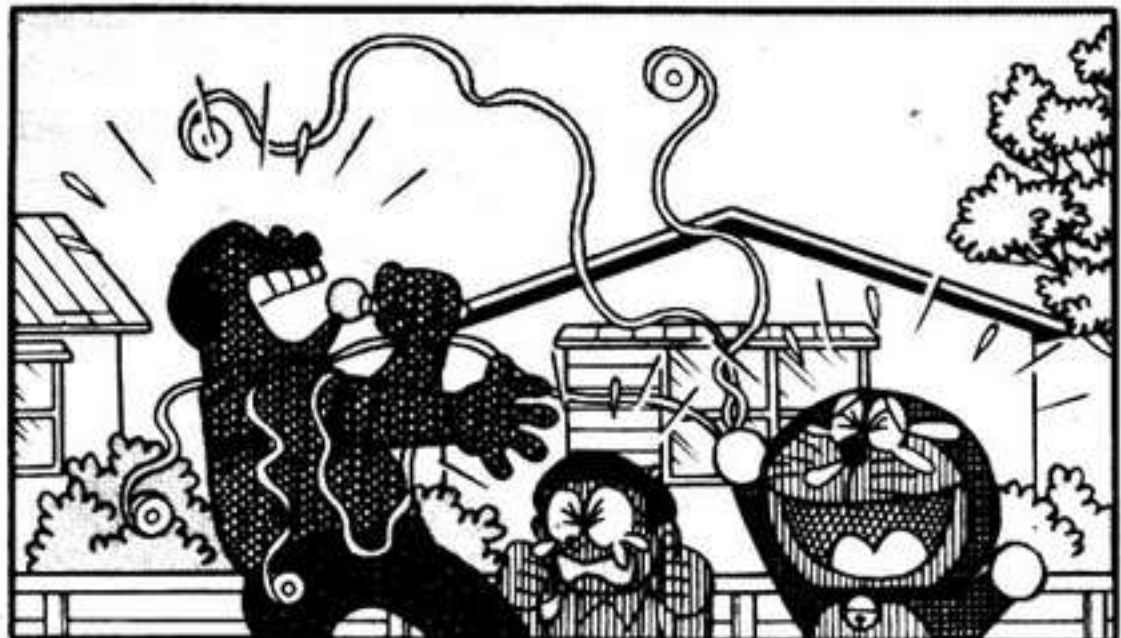

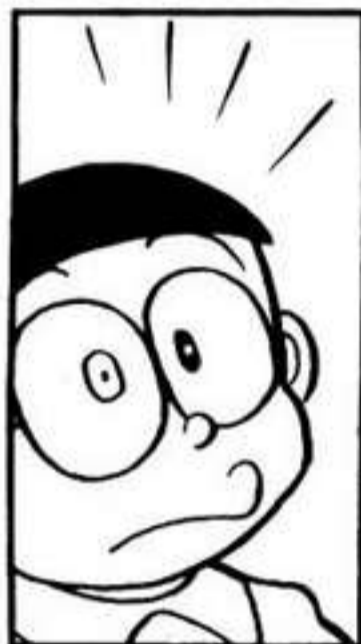



เห็น
ใจแอนท์
มัย



ผิดสัญญาเนีย
เป็นลูกผู้ชาย
รีเปล่า!!



ว่า
อยากฟัง
จังเลย

มันมีนง
หงุดหงิด



พ่อ รีบมา
ทานข้าว
เร็วเข้า!

ซุบจะเย็น
หมด
นะคะ



รอกันกว่าพ่อจะ
เคี้ยวแผ่นที่
ใส่ปากตะกั
หมดก่อน

ฤทธิ์ยานั้น
แรงเกินไป
รีเปล่านะ

ควั่น
ควั่น

||จิ้น

ໃນບັດະເສື້ອປີນໄວ



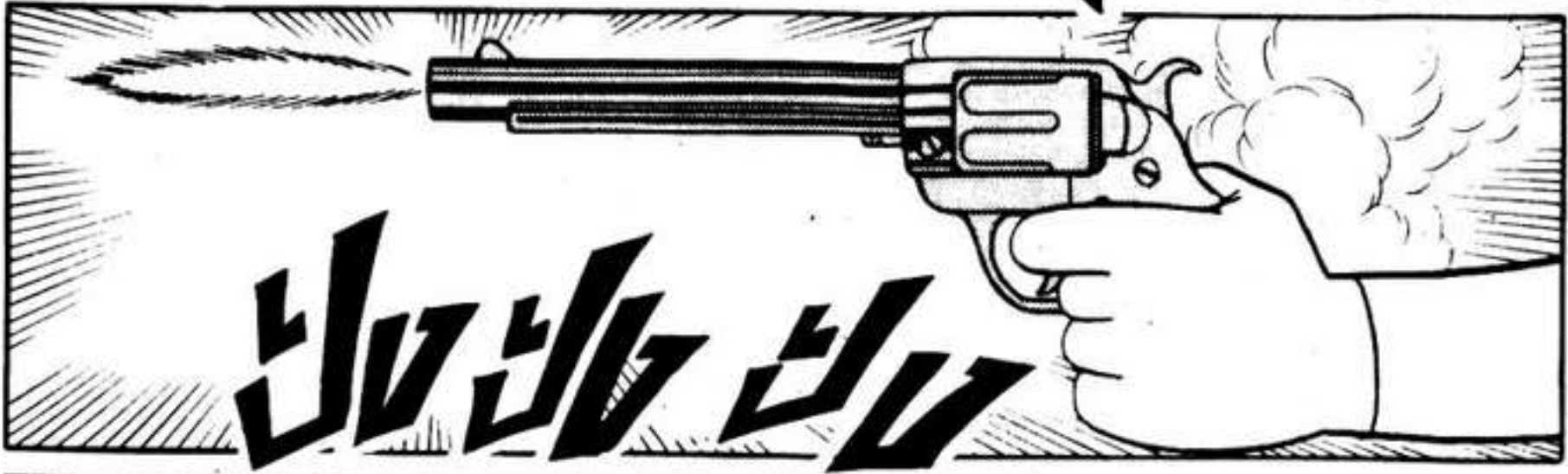

เพอร์เฟ็ค 3 หมิ่นแแต่่ม
สถิติโลกของเกม
ตะวันตกเลยหละ!!



นายเนี่ยมมีพรสวรรค์
ทางยิงปืนกับ
พันด้าย....





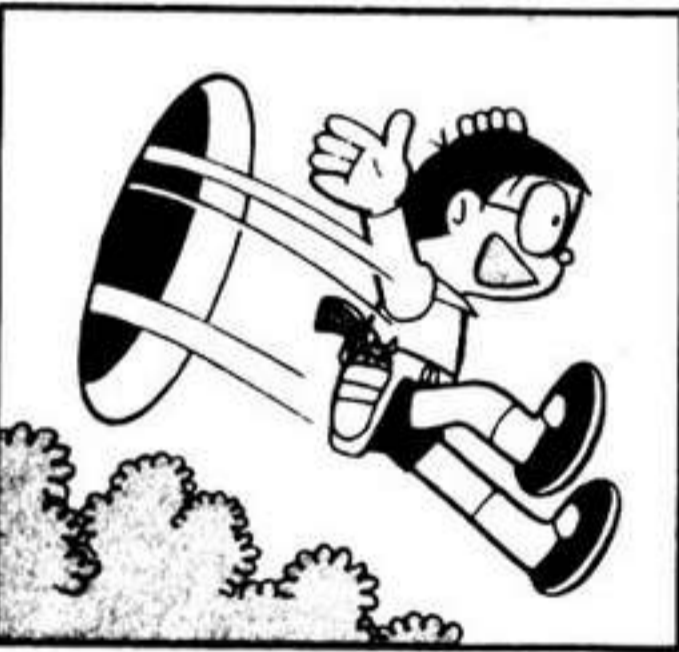
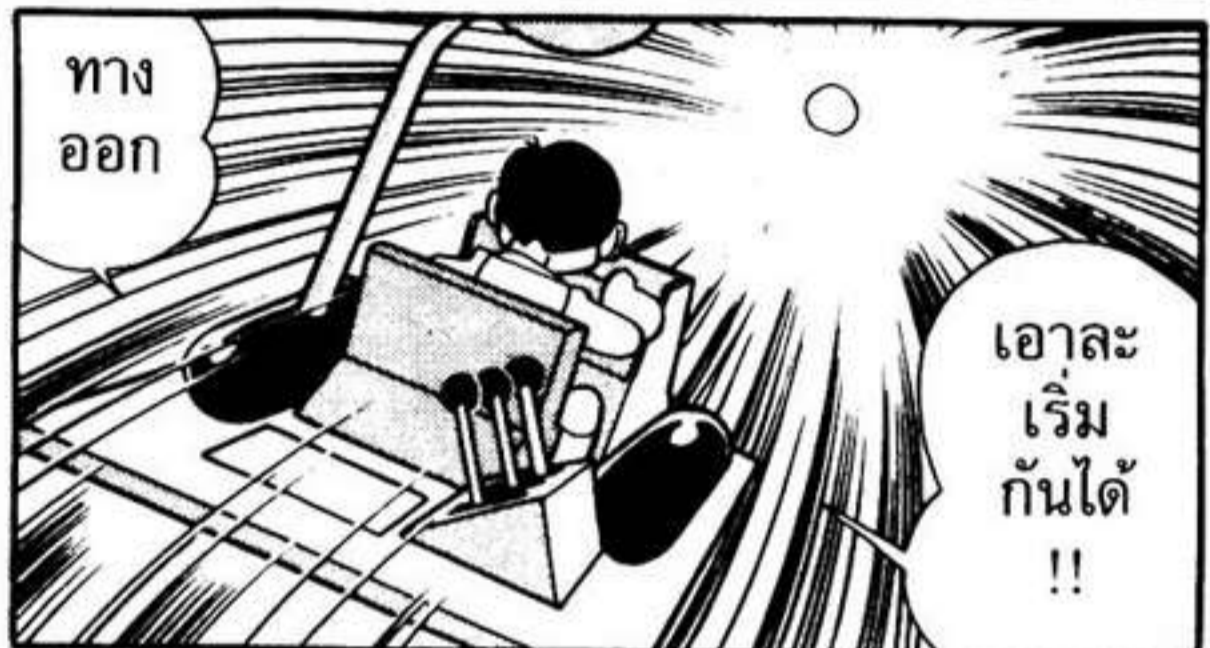

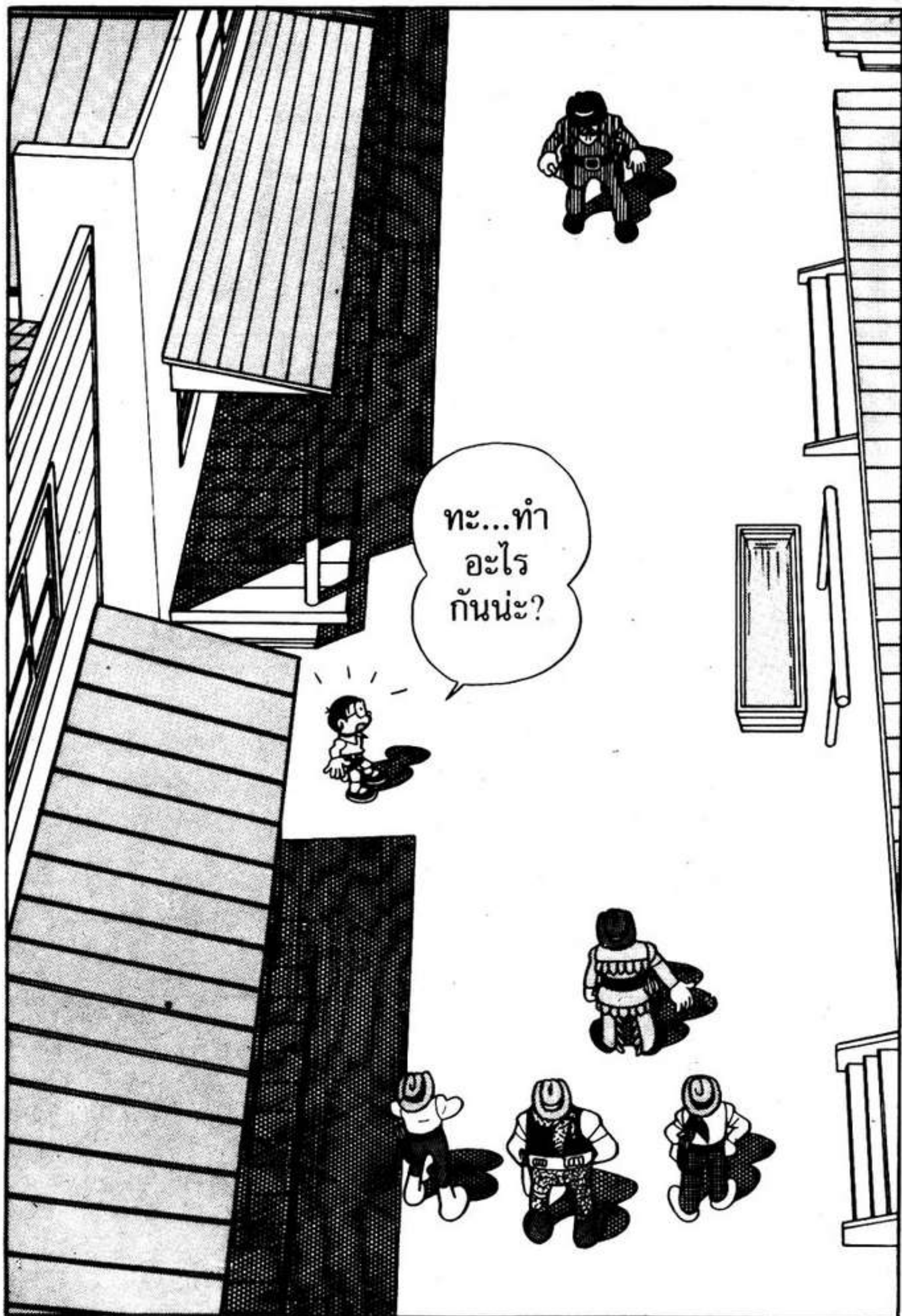

ทะเล...ทำ
อะไร
กันนะ?

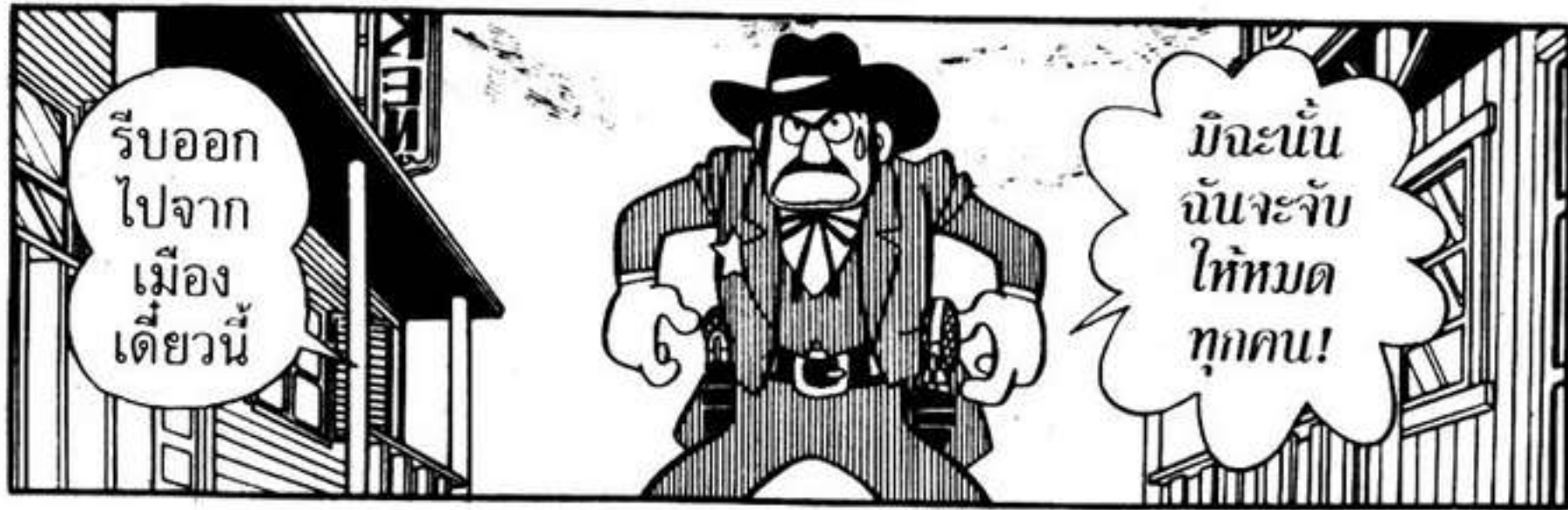

รีบออกไปจาก
เมือง
เดี๋ยวนี้

มีฉะนั้น
ฉันจะจับ
ให้หมด
ทุกคน!



พุด
อะไรลึ่ง

ทุกคนไม่ต้องช่วย
ให้ข้าจัดการ
เอง

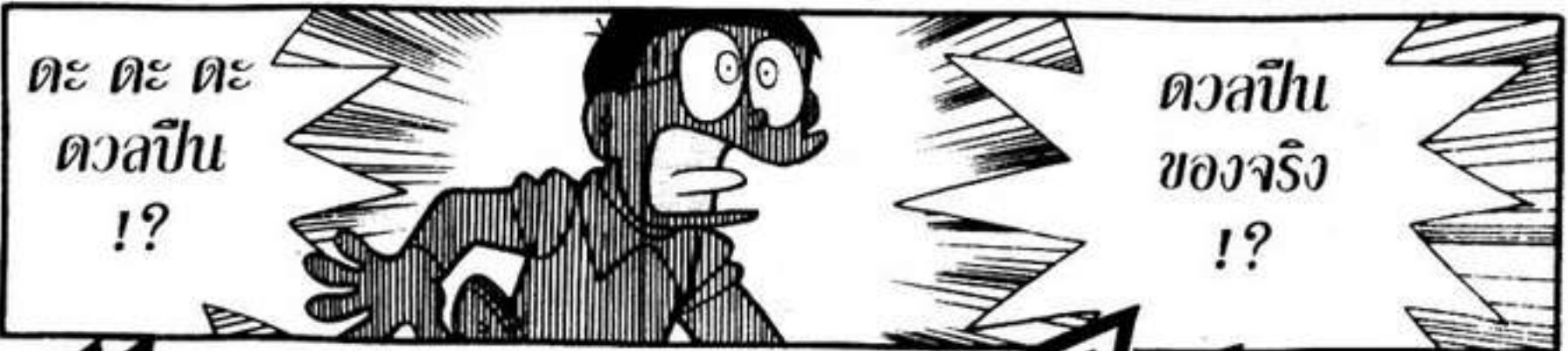

ตะ ตะ ตะ
ดวลปืน
!?

ดวลปืน
ของจริง
!?

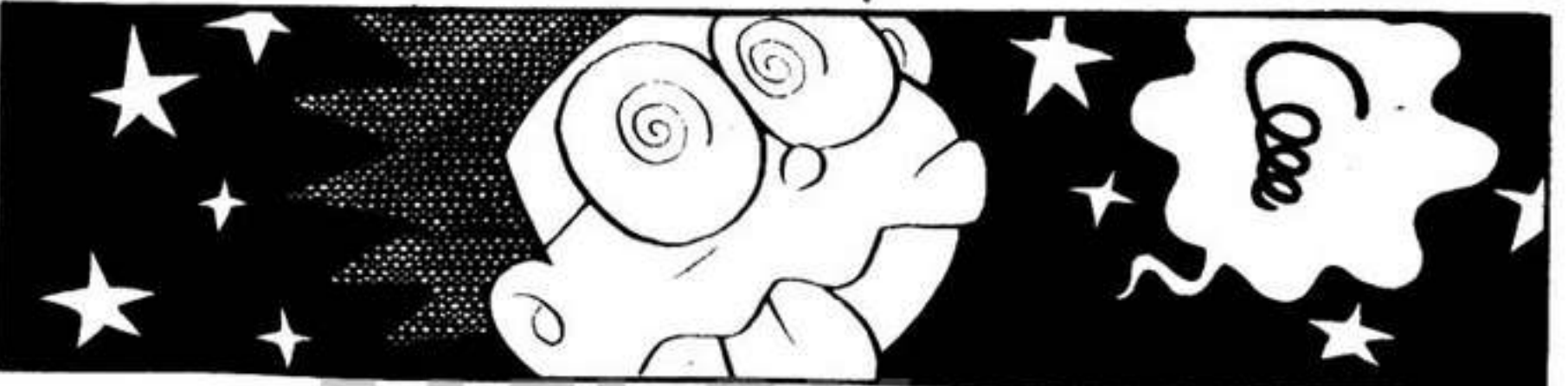





พีน
จนได้

โชคดีจัง
เพราะเสียง
ยิงปืน
เลยสลับ
ไปจ๊ะ

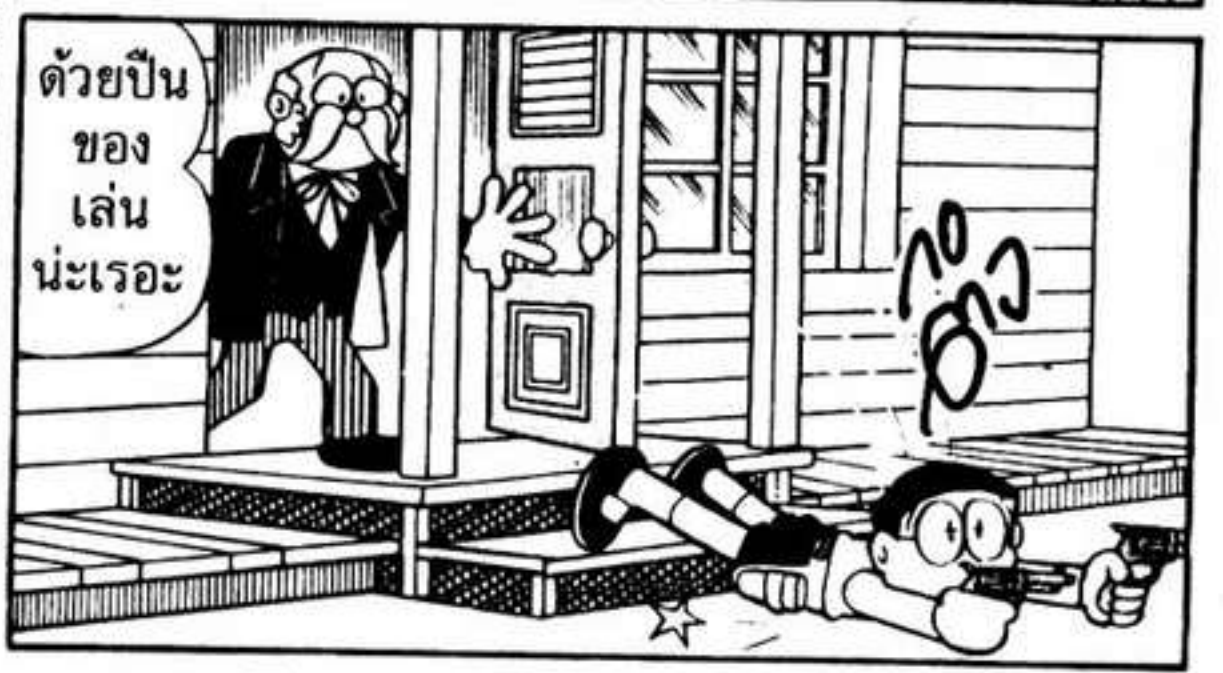





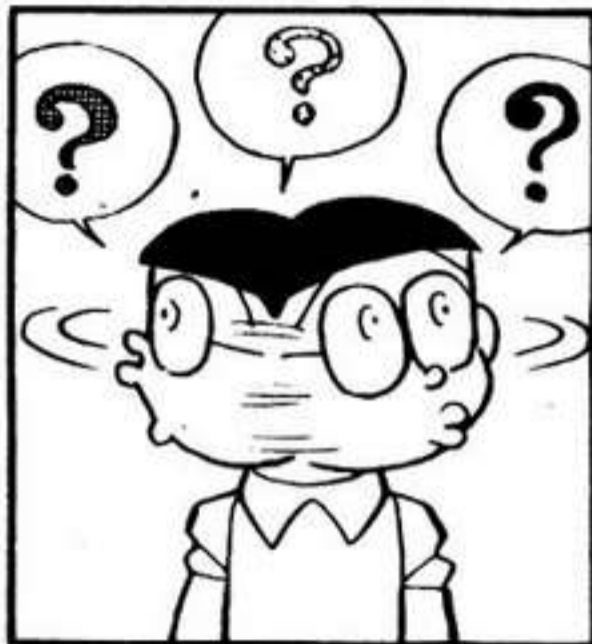







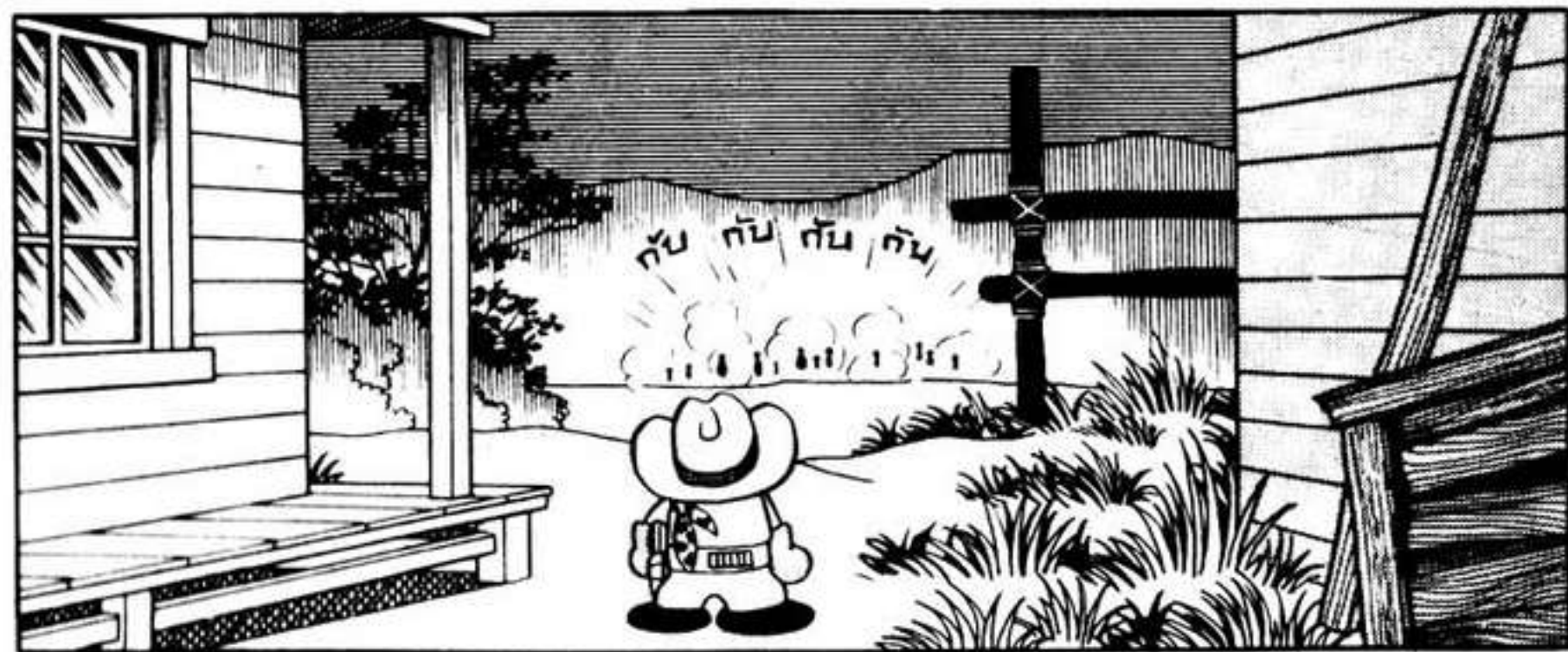



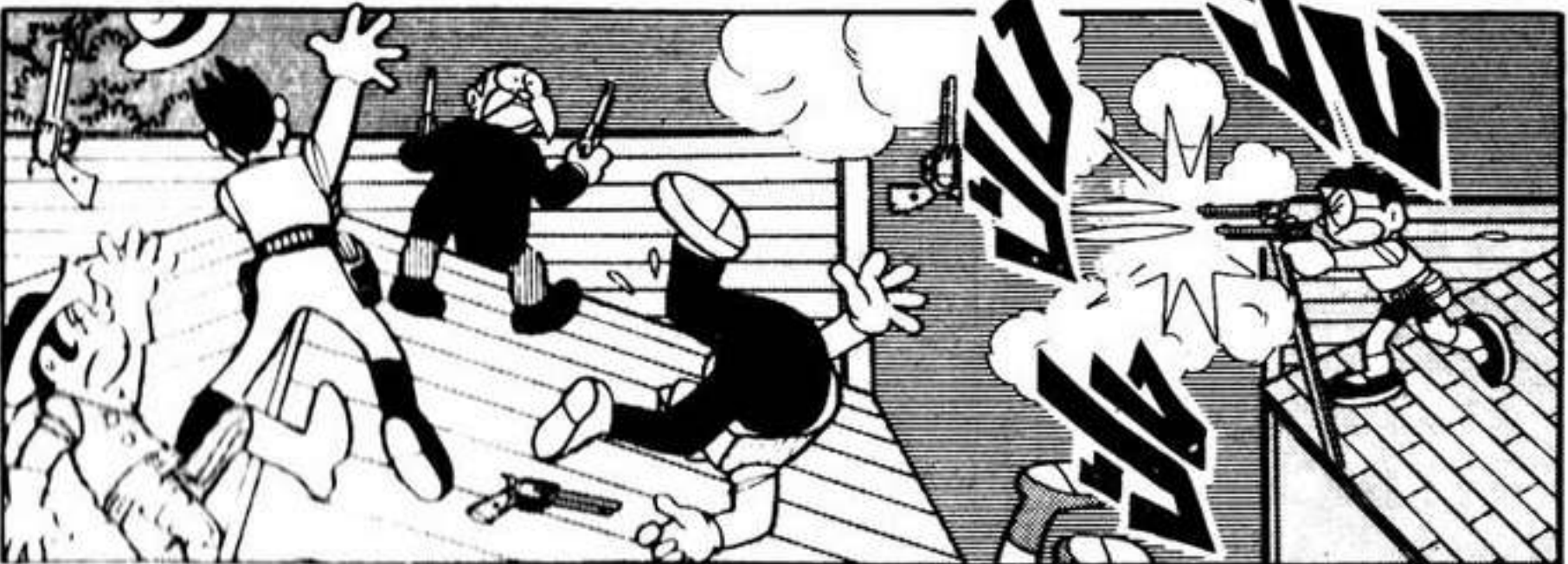
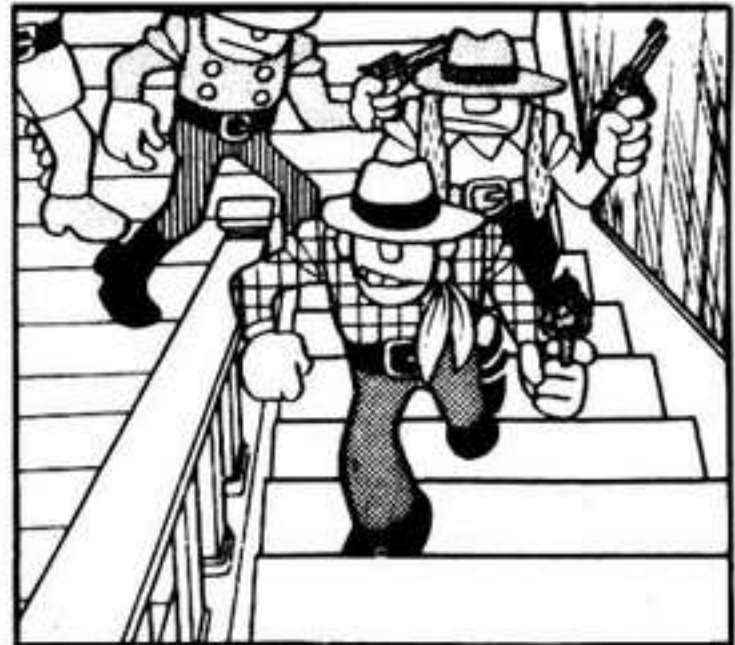
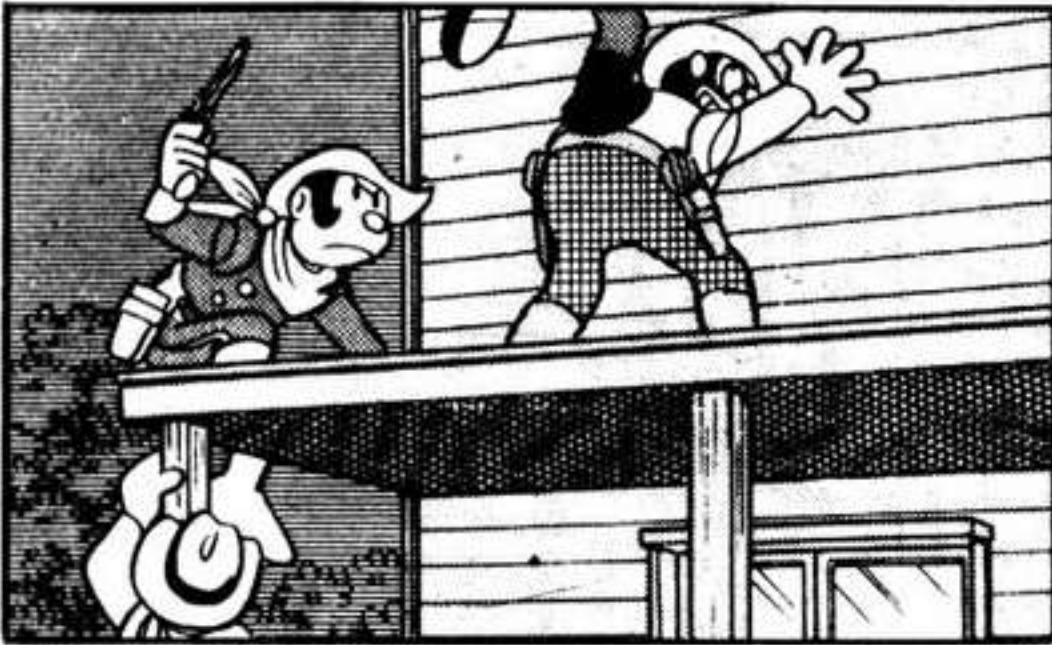



กระสุน
หมด
แล้ว!

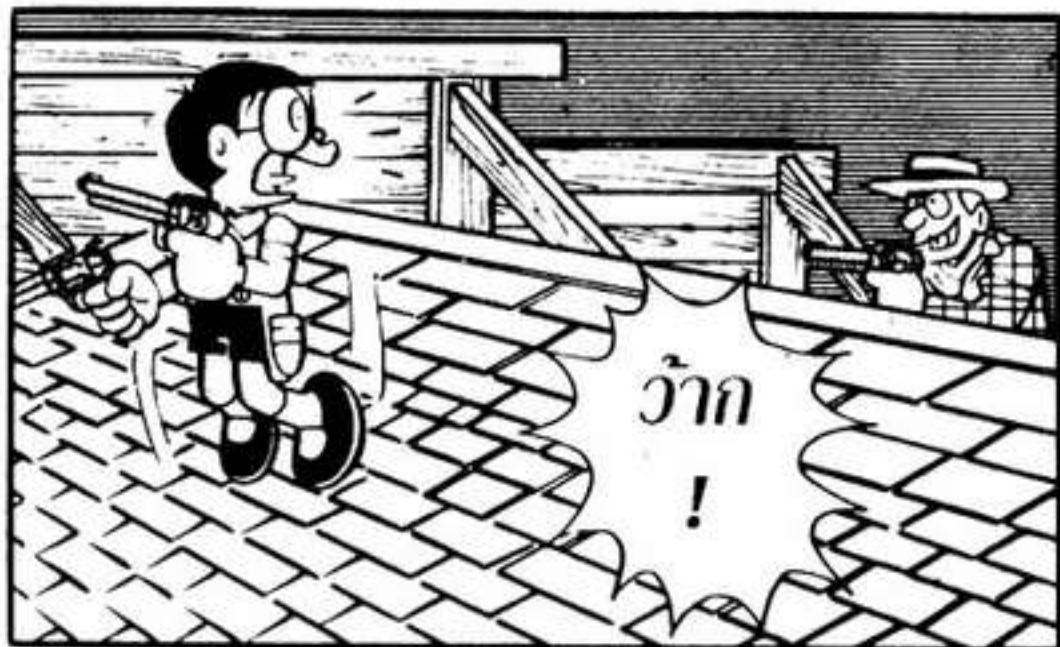

ว๊าก!
!



เป็น
อะไรไป

เข่าอ่อน
จนขยับ
ตัวไม่ได้
เลยหรือ

งั้น
ที่เข้า
ละนะ





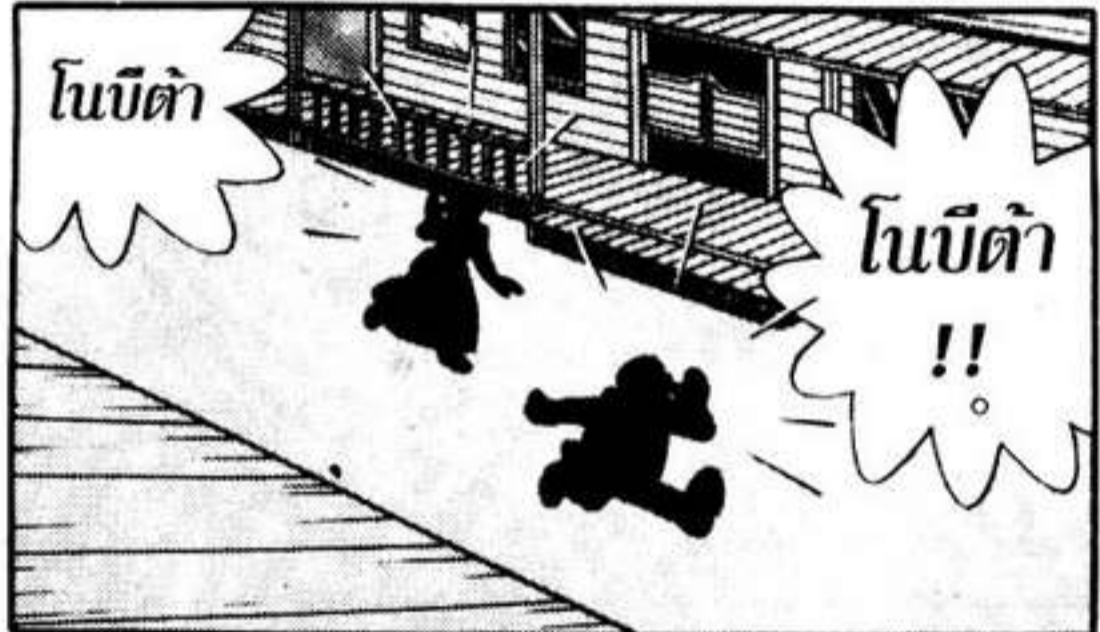

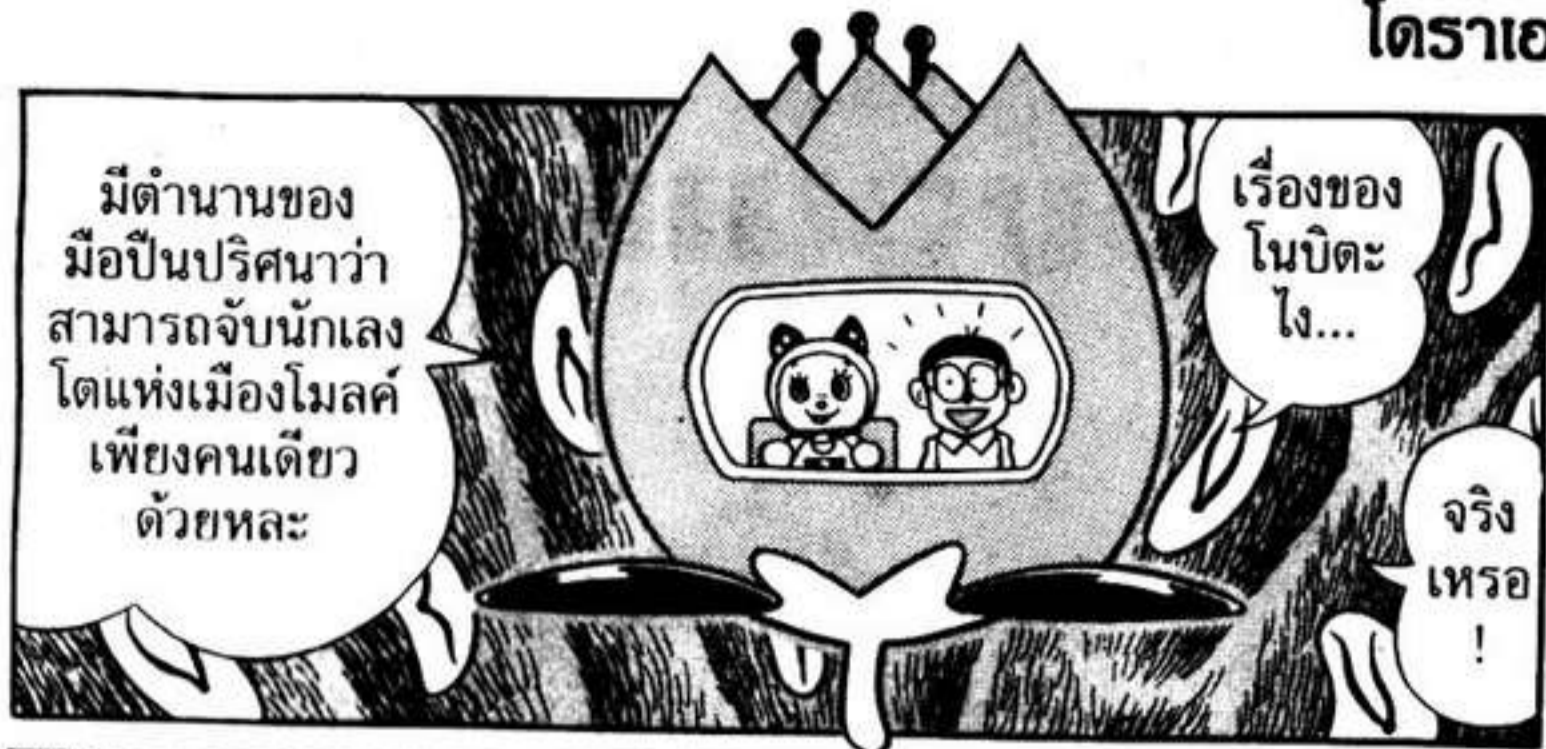

มีตำนานของ
มือปืนปริศนาว่า
สามารถจับนักเลง
โตแห่งเมืองโมลด์
เพียงคนเดียว
ด้วยทะเล

เรื่องของ
โนบิตะ
ไง...

จริง
เทร่อ
!



ปัง ปัง



ใจแอนท์
เก่งจังเลย

โนบิตะก็ถูก
ยิงแล้วนะ

ล้ม
ลง
สิ



แต่
ว่า!
แต่
ว่า!
!

ก็ฉัน
ไม่มีทางแพ้
เด็ดขาด

โนบิตะคือ
ดันทุรัง
เนี่ย
แปลกแฮะ

ไดรอสและเพื่อน

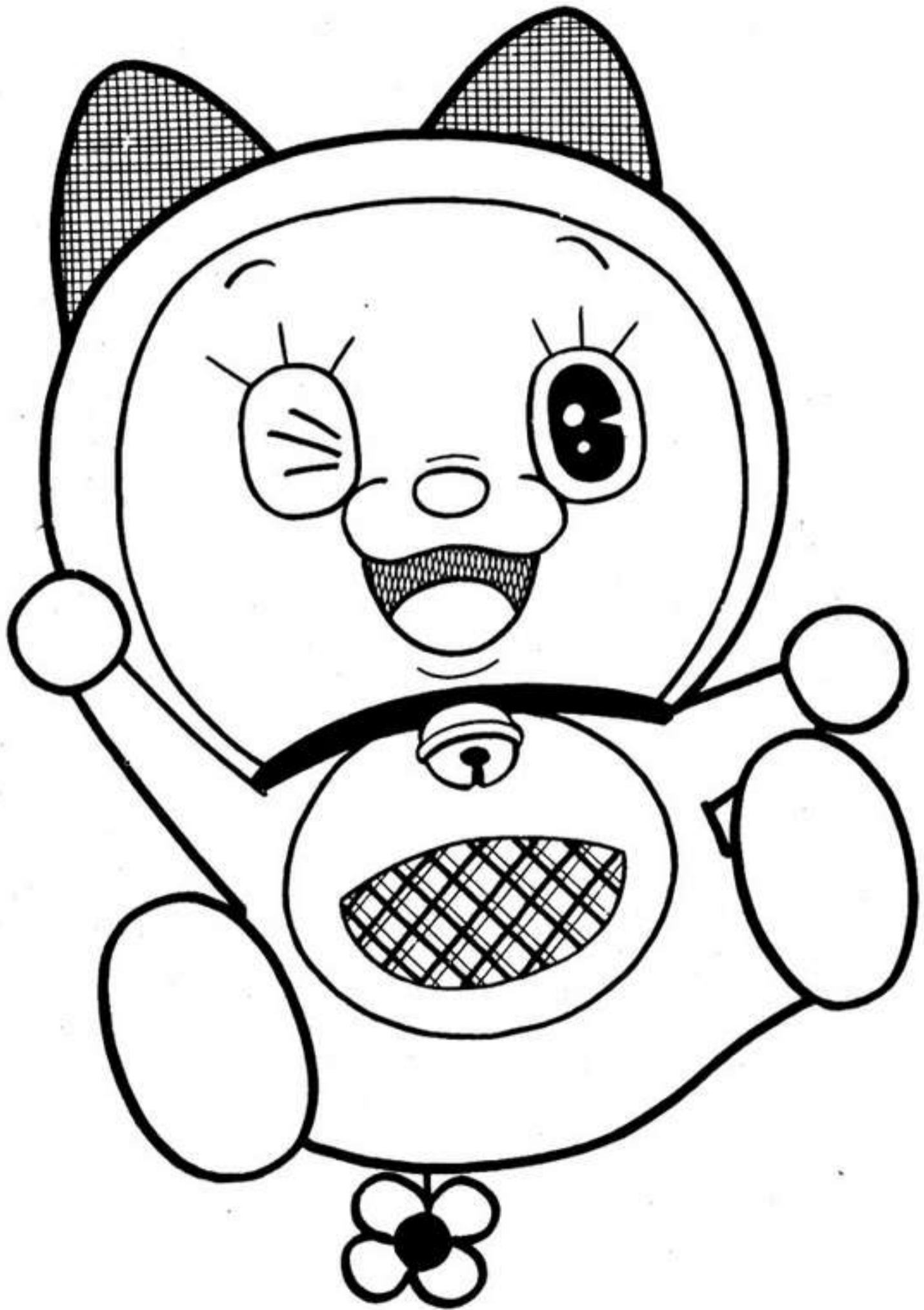





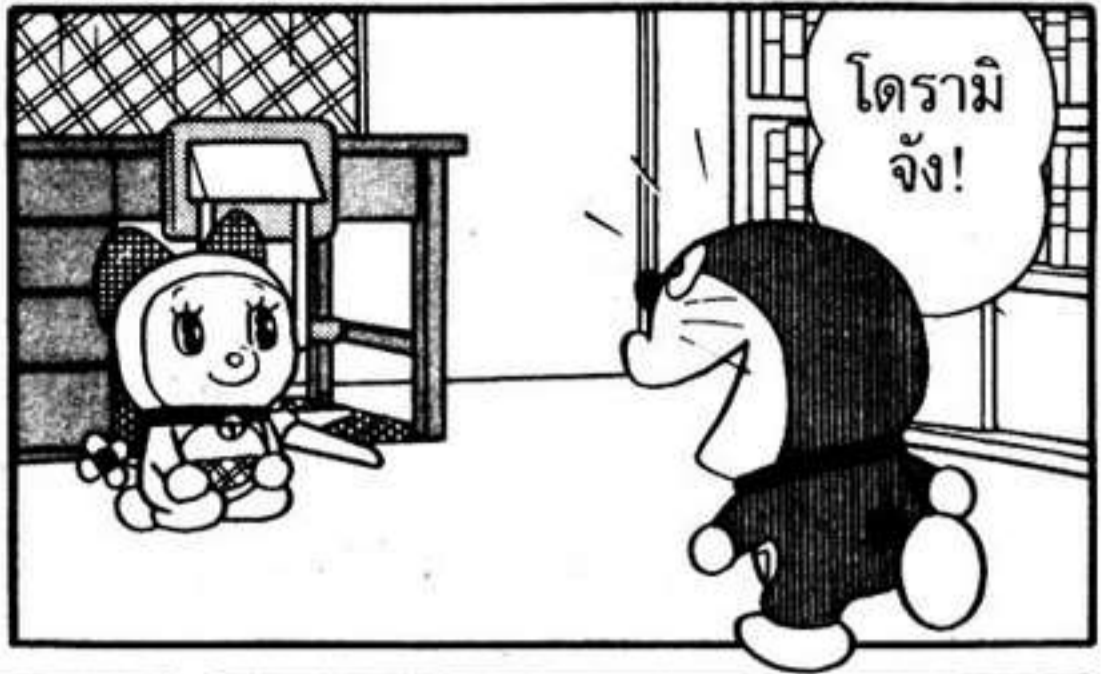

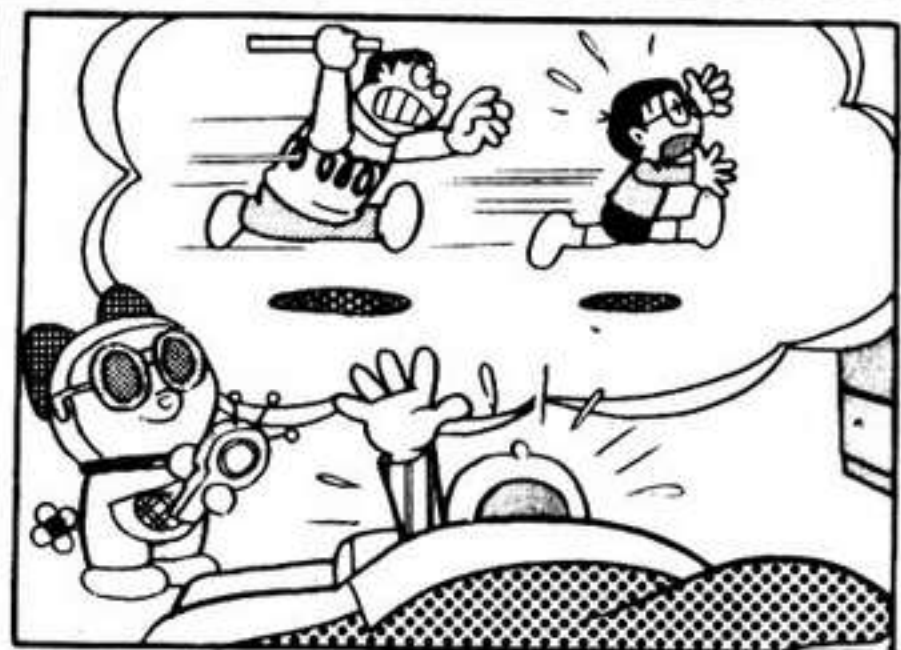
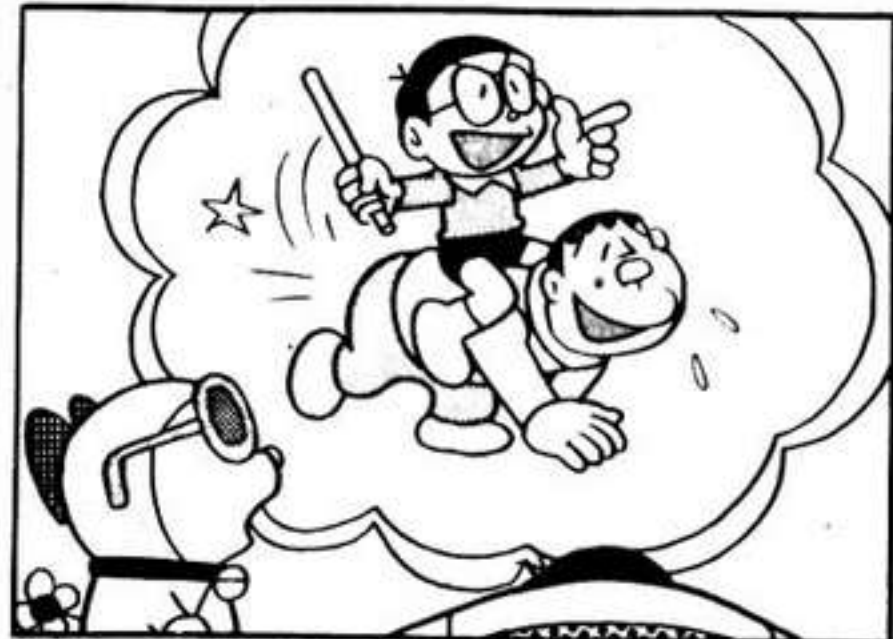
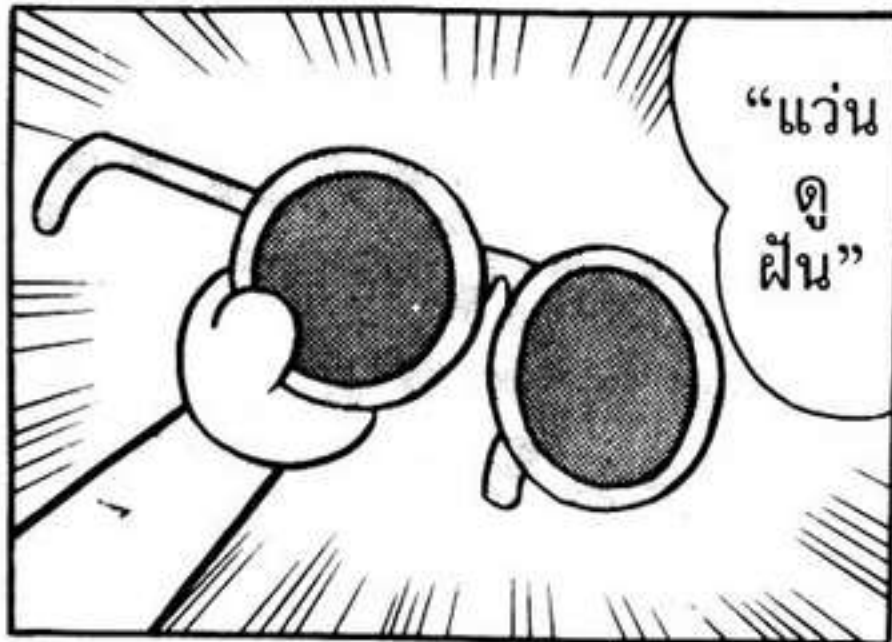





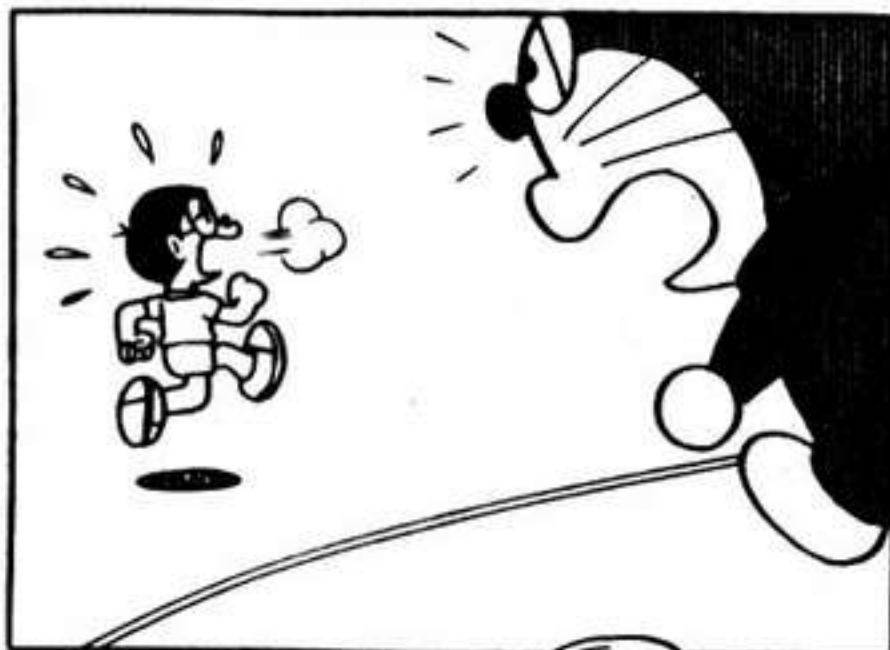
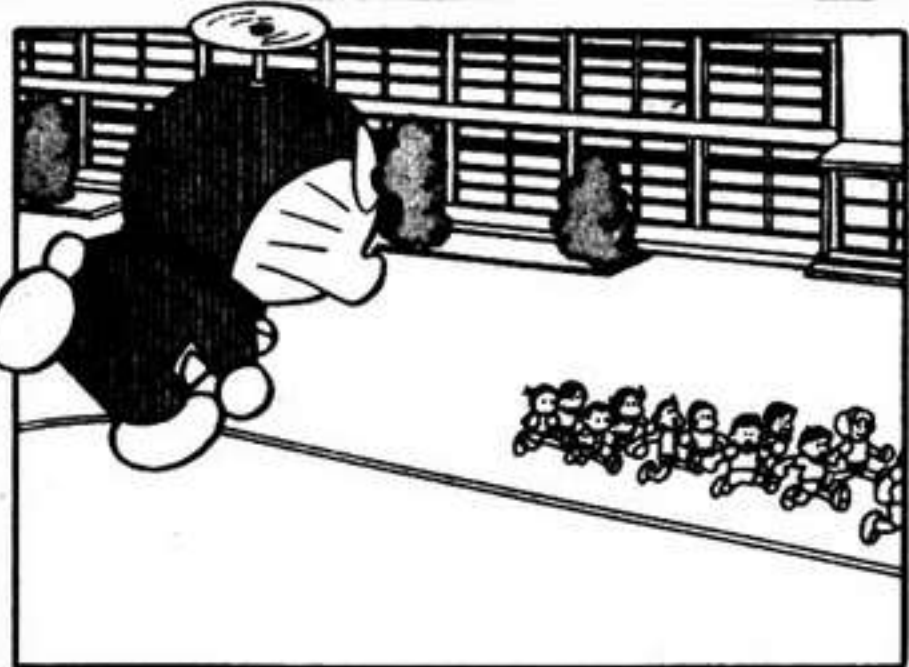
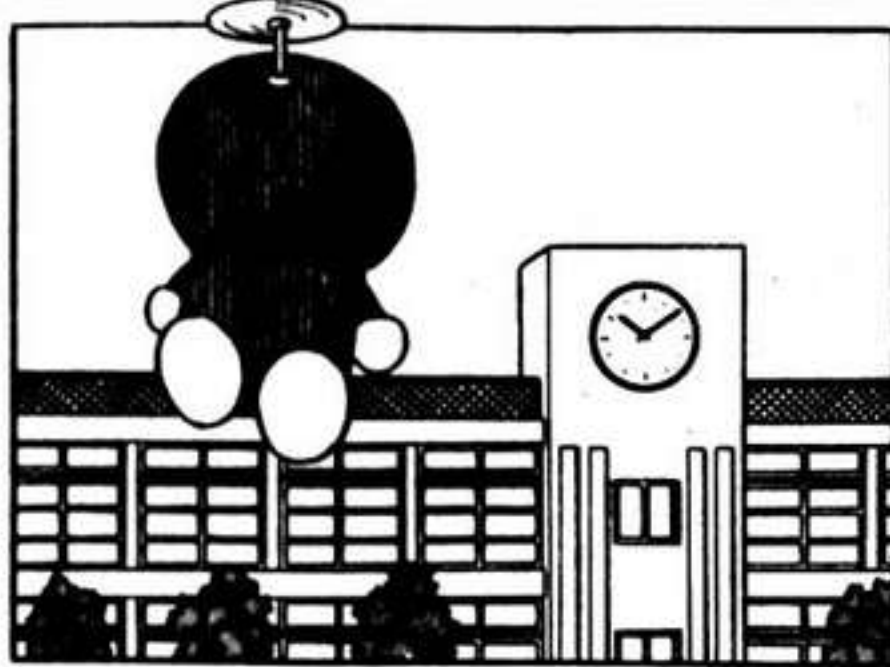

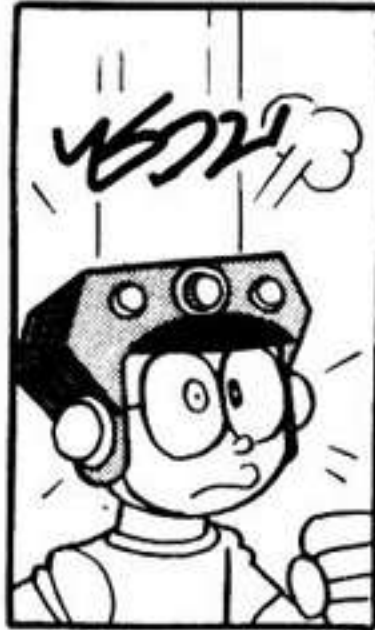

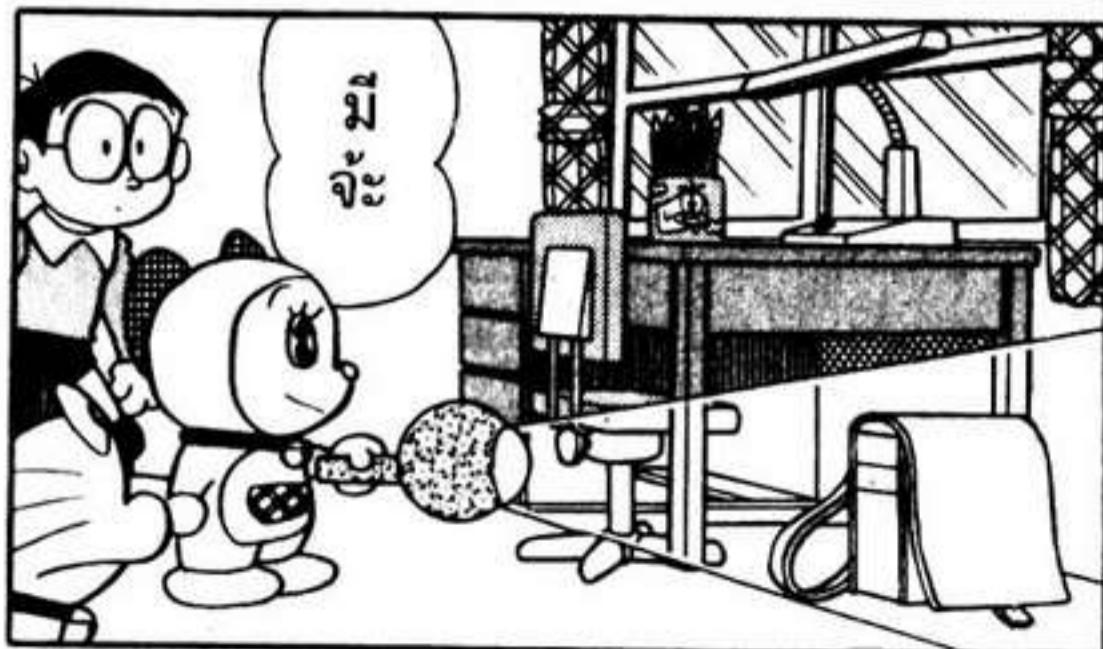



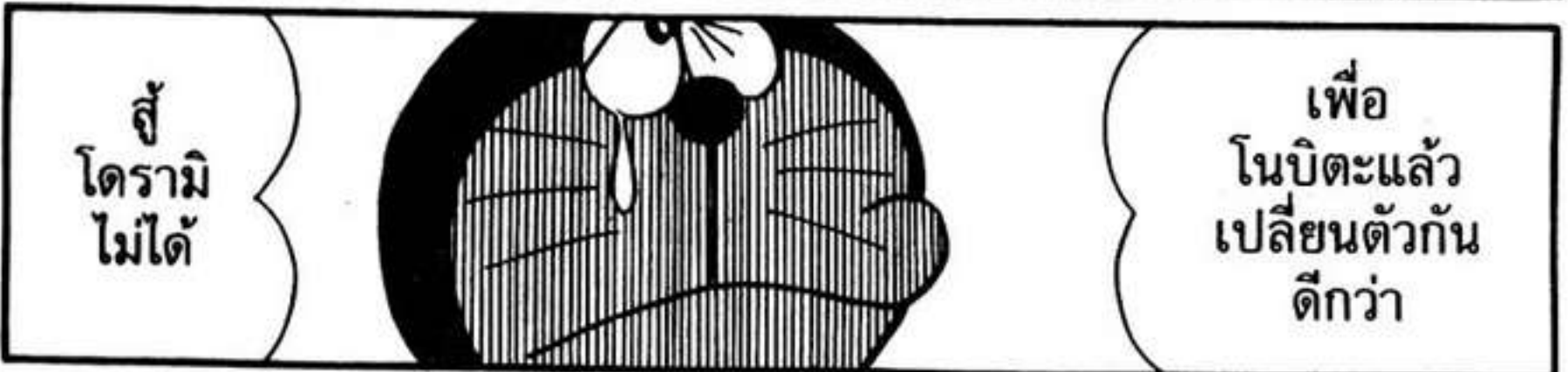



ไม่ยอม!

ฉันไม่ให้กลับไปเด็ดขาด!



แต่...แต่ว่า
เครื่องมือที่ฉัน
เอาออกมาทำให้
นายแย่ง...

ฉันผิดเอง
เพราะฉันใช้มัน
ตามอำเภอใจ



ต่อไปฉันจะทำตามที่นายพูด
ไม่นอนกลางวัน! จะทำการบ้าน!
เพราะยังงั้น! ซอ! ซอ! ซอ!



เราคง
ต้องหวัง
ผลใน
ระยะไกล



ถึงจะทะเลาะ
กันประจำ
แต่ที่จริงแล้ว
รักกันนะจ๊ะ